

www.osaka.com.tr

# OSAKA®

**2019**  
**Profesyonel**  
Havalı El Aletleri  
Katalođu







Somun Sökmeler	4-10
Circır Motorları / Dijital Tork Kolları	11-12
Matkap Motorları	13-14
Tornavidalar	15-18
Kılavuz Çekmeler / Paralel Kollar	19-21
Çivi Çakmalar / Koli Kapamalar	22-23
Yan Kesimler / Sac Kesmeler / Cam Fıtil Kesme / Eğe Motoru / Çelik Kalem / Çember Makinası	24-25
Kalıpçı Taşlamalar	26-28
Boru Taşlamalar / Mikro Kalıpçı Taşlamalar	29-30
Taşlamalar	31-32
Polisajlar	33
Zımparalar	34-36
Testere Motorları / Havalı Tokmak / Punta Çürütme	37
Perçin Tabancaları	38-40
Kalafat Çekiçleri / Çivili Raspalar	42-43
Silikon Tabancaları / Gres Pompası	44
Mikserler / Kaporta Çektirme / Vakumlu Süpürge	45
Şartlandırıcılar / Su Tutucular	46-47
Osaka Hortumlar	50-53
Tecna	56-58
Osaka Lokmalar	62-74
Lüdecke	78-80
Osaka Aksesuarlar	84-93
Osafix Perçinler	96-100
Heller	102-103
Prego	104-105
Servisler	106
Teknik Bilgiler	107-109
Banka Hesap Bilgileri	110





**Y M T**  
**KİMYA & HİRDAVAT**  
Solution partner

Havalı El Aletleri



### OPT 375 3/8" SOMUN SÖKME



TEK ÇEKİÇ	
Uzunluk	139 mm
Civata Çapı	12 mm
Soket Karesi	3/8"
Max. Tork	102 Nm
Boşta Devir	10.000 Rpm
Hava Tüketimi	113 lt/dk
Hava Giriş Nipeli	1/4"
Hortum Çapı	8.00 mm
Çalışma Basıncı	90 psi (6.2 atü)
Ağırlık	0.95 kg
Koli Adedi	20 adet

### OPT 371 3/8" SOMUN SÖKME



TEK ÇEKİÇ	
Uzunluk	112 mm
Civata Çapı	12 mm
Soket Karesi	3/8"
Max. Tork	102 Nm
Boşta Devir	9.000 Rpm
Hava Tüketimi	100 lt/dk
Hava Giriş Nipeli	1/4"
Hortum Çapı	8.00 mm
Çalışma Basıncı	6.3-8 atü
Ağırlık	1.1 kg
Koli Adedi	20 adet

### OPT 517 1/2" SOMUN SÖKME



İKİZ ÇEKİÇ	
Uzunluk	185 mm
Civata Çapı	18 mm
Soket Karesi	1/2"
Max. Tork	651 Nm
Boşta Devir	7.000 Rpm
Hava Tüketimi	120 lt/dk
Hava Giriş Nipeli	1/4"
Hortum Çapı	10.00 mm
Çalışma Basıncı	90 psi (6.2 atü)
Ağırlık	2.55 kg
Koli Adedi	10 adet

### OPT 517K 1/2" SOMUN SÖKME SET



İKİZ ÇEKİÇ	
1 adet OPT 517 + 10 adet Lokma + 1 adet Plastik Çanta + 1 adet 125 mm Uzatma	
Lokmalar 1/2"	9-10-11-13-14-17-19-22-24-27 mm
Hava Giriş Nipeli	1/4"
Hava Tüketimi	120 lt/dk
Çalışma Basıncı	90-115 psi (6.2 atü)
Ağırlık	2.55 kg
Koli Adedi	2 adet

### OPT-P 243 3/8" SOMUN SÖKME



İKİZ ÇEKİÇ	
Uzunluk	155 mm
Civata Çapı	14 mm
Soket Karesi	3/8"
Max. Tork	298 Nm
Boşta Devir	10.000 Rpm
Hava Tüketimi	80 lt/dk
Hava Giriş Nipeli	1/4"
Hortum Çapı	10.00 mm
Çalışma Basıncı	90 psi (6.2 atü)
Ağırlık	1.50 kg
Koli Adedi	10 adet

### OPC 50138 3/8" SOMUN SÖKME



TEK ÇEKİÇ	
Uzunluk	127 mm
Civata Çapı	8 mm
Soket Karesi	3/8"
Max. Tork	70 Nm
Boşta Devir	12.000 Rpm
Hava Tüketimi	120 lt/dk
Hava Giriş Nipeli	1/4"
Hortum Çapı	8.00 mm
Çalışma Basıncı	90 psi (6.2 atü)
Ağırlık	0.73 kg
Koli Adedi	20 adet

### OPT-P 519 1/2" SOMUN SÖKME



İKİZ ÇEKİÇ	
Uzunluk	155 mm
Civata Çapı	16 mm
Soket Karesi	1/2"
Max. Tork	850 Nm
Boşta Devir	7.400 Rpm
Hava Tüketimi	250 lt/dk
Hava Giriş Nipeli	1/4"
Hortum Çapı	10.00 mm
Çalışma Basıncı	90 psi (6.2 atü)
Ağırlık	2.50 kg
Koli Adedi	6 adet

### OPT-P 520 1/2" SOMUN SÖKME



İKİZ ÇEKİÇ	
Uzunluk	164 mm
Civata Çapı	18 mm
Soket Karesi	1/2"
Max. Tork	1.054 Nm
Boşta Devir	6.200 Rpm
Hava Tüketimi	300 lt/dk
Hava Giriş Nipeli	1/4"
Hortum Çapı	10.00 mm
Çalışma Basıncı	90 psi (6.2 atü)
Ağırlık	2.20 kg
Koli Adedi	6 adet

### OPC 50238C 3/8" SOMUN SÖKME



İKİZ ÇEKİÇ - COMPOSITE	
Uzunluk	165 mm
Civata Çapı	14 mm
Soket Karesi	3/8"
Max. Tork	434 Nm
Boşta Devir	12.000 Rpm
Hava Tüketimi	210 lt/dk
Hava Giriş Nipeli	1/4"
Hortum Çapı	10.00 mm
Çalışma Basıncı	6.3-8 atü
Ağırlık	1.20 kg
Koli Adedi	10 adet

### OPT-P 59212 1/2" SOMUN SÖKME ŞARJLI



1/2" ŞARJLI SOMUN SÖKME SET	
Civata Çapı	14 mm
Soket Karesi	1/2"
Max. Tork	474 Nm
Devir	2.300 Rpm
Batarya	19.2 V/Li-ion
Şarj Süresi	60 dakika
Ağırlık	1.90 kg
Standart Aksesuar	1 adet 19.2 V Akü, Şarj Ünitesi
Koli Adedi	6 adet

### OPT-P 504C MİNİ SOMUN SÖKME



MİNİ SOMUN SÖKME	
Uzunluk	90 mm
Civata Çapı	16 mm
Soket Karesi	1/2"
Max. Tork	610 Nm
Boşta Devir	9.000 Rpm
Hava Tüketimi	300 lt/dk
Hava Giriş Nipeli	1/4"
Hortum Çapı	8.00 mm
Çalışma Basıncı	90 psi (6.2 atü)
Ağırlık	1.19 kg
Koli Adedi	12 adet



### OPC 51212C 1/2" SOMUN SÖKME



İKİZ ÇEKİÇ	
Uzunluk	190 mm
Civata Çapı	19 mm
Soket Karesi	1/2"
Max. Tork	1.359 Nm
Boşta Devir	7.500 Rpm
Hava Tüketimi	180 lt/dk
Hava Giriş Nipeli	1/4"
Hortum Çapı	10.00 mm
Çalışma Basıncı	90-115 psi (6.2-8.0 atü)
Ağırlık	1.97 kg
Koli Adedi	8 adet

### OPC 51212CL 1/2" SOMUN SÖKME



İKİZ ÇEKİÇ	
Uzunluk	240 mm
Civata Çapı	19 mm
Soket Karesi	1/2"
Max. Tork	1.359 Nm
Boşta Devir	7.500 Rpm
Hava Tüketimi	180 lt/dk
Hava Giriş Nipeli	1/4"
Hortum Çapı	10.00 mm
Çalışma Basıncı	90-115 psi (6.2-8.0 atü)
Ağırlık	2.10 kg
Koli Adedi	8 adet

### OPC 51234C 3/4" SOMUN SÖKME



İKİZ ÇEKİÇ	
Uzunluk	230 mm
Civata Çapı	32 mm
Soket Karesi	3/4"
Max. Tork	1.900 Nm
Boşta Devir	5.500 Rpm
Hava Tüketimi	235 lt/dk
Hava Giriş Nipeli	3/8"
Hortum Çapı	10.00 mm
Çalışma Basıncı	90 psi (6.2 atü)
Ağırlık	3.40 kg
Koli Adedi	4 adet

### OPC 51234CL 3/4" SOMUN SÖKME



İKİZ ÇEKİÇ	
Uzunluk	330 mm
Civata Çapı	32 mm
Soket Karesi	3/4"
Max. Tork	1.900 Nm
Boşta Devir	5.500 Rpm
Hava Tüketimi	235 lt/dk
Hava Giriş Nipeli	3/8"
Hortum Çapı	10.00 mm
Çalışma Basıncı	90 psi (6.2 atü)
Ağırlık	3.90 kg
Koli Adedi	4 adet

### OPT 600 3/4" SOMUN SÖKME



TEK ÇEKİÇ	
Uzunluk	243 mm
Civata Çapı	22 mm
Soket Karesi	3/4"
Max. Tork	670 Nm
Boşta Devir	4.800 Rpm
Hava Tüketimi	205 lt/dk
Hava Giriş Nipeli	1/4"
Hortum Çapı	10.00 mm
Çalışma Basıncı	90 psi (6.2 atü)
Ağırlık	4.80 kg
Koli Adedi	4 adet

### OPT 600K 3/4" SOMUN SÖKME SET



TEK ÇEKİÇ	
OPT 600	1 adet
Lokma	8 adet
Plastik Çanta	1 adet
Lokmalar 3/4"	26-27-29-30-32 35-36-38.00 mm
Koli Adedi:	2 adet

### OPC 51134 3/4" SOMUN SÖKME



İKİZ ÇEKİÇ	
Uzunluk	226 mm
Civata Çapı	30 mm
Soket Karesi	3/4"
Max. Tork	1.200 Nm
Boşta Devir	5.000 Rpm
Hava Tüketimi	320 lt/dk
Hava Giriş Nipeli	1/4"
Hortum Çapı	13.00 mm
Çalışma Basıncı	90-115 psi (6.2-8.0 atü)
Ağırlık	5.00 kg
Koli Adedi	4 adet

### OPT-P 625 3/4" SOMUN SÖKME



PİN ÇEKİÇ	
Uzunluk	248 mm
Civata Çapı	27 mm
Soket Karesi	3/4"
Max. Tork	1.086 Nm
Boşta Devir	4.800 Rpm
Hava Tüketimi	205 lt/dk
Hava Giriş Nipeli	1/4"
Hortum Çapı	10.00 mm
Çalışma Basıncı	90 psi (6.2 atü)
Ağırlık	4.90 kg
Koli Adedi	4 adet

### OPT-P 508E 3/4" SOMUN SÖKME



İKİZ ÇEKİÇ	
Uzunluk	230 mm
Civata Çapı	36 mm
Soket Karesi	3/4"
Max. Tork	1.646 Nm
Boşta Devir	4.500 Rpm
Hava Tüketimi	215 lt/dk
Hava Giriş Nipeli	1/4"
Hortum Çapı	11.00 mm
Çalışma Basıncı	90 psi (6.2 atü)
Ağırlık	6.00 kg
Koli Adedi	4 adet





### OPT-P 316 1" SOMUN SÖKME



TEK ÇEKİÇ	
Uzunluk	300 mm
Civata Çapı	38 mm
Soket Karesi	1"
Max. Tork	1.900 Nm
Boşta Devir	3.500 Rpm
Hava Tüketimi	312 lt/dk
Hava Giriş Nipeli	1/2"
Hortum Çapı	13.00 mm
Çalışma Basıncı	90-115 psi (6.2-8 atü)
Ağırlık	9.60 kg
Koli Adedi	2 adet

### OPT-P 316L 1" SOMUN SÖKME



TEK ÇEKİÇ	
Uzunluk	450 mm
Civata Çapı	38 mm
Soket Karesi	1"
Max. Tork	1.900 Nm
Boşta Devir	3.500 Rpm
Hava Tüketimi	312 lt/dk
Hava Giriş Nipeli	1/2"
Hortum Çapı	13.00 mm
Çalışma Basıncı	90-115 psi (6.2-8 atü)
Ağırlık	10.10 kg
Koli Adedi	2 adet

### OPT-P 418 1" SOMUN SÖKME



SWING HAMMER	
Uzunluk	310 mm
Civata Çapı	55 mm
Soket Karesi	1"
Max. Tork	3.400 Nm
Boşta Devir	3.000 Rpm
Hava Tüketimi	600 lt/dk
Hava Giriş Nipeli	1/2"
Hortum Çapı	13.00 mm
Çalışma Basıncı	6.3-8 atü
Ağırlık	13.8 kg
Koli Adedi	1 adet

### OPT-P 418L 1" SOMUN SÖKME



SWING HAMMER	
Uzunluk	430 mm
Civata Çapı	55 mm
Soket Karesi	1"
Max. Tork	3.400 Nm
Boşta Devir	3.000 Rpm
Hava Tüketimi	600 lt/dk
Hava Giriş Nipeli	1/2"
Hortum Çapı	13.00 mm
Çalışma Basıncı	6.3-8 atü
Ağırlık	14.60 kg
Koli Adedi	1 adet

### OPT-P 317 1" SOMUN SÖKME



SWING HAMMER	
Uzunluk	285 mm
Civata Çapı	40 mm
Soket Karesi	1"
Max. Tork	2.400 Nm
Boşta Devir	4.200 Rpm
Hava Tüketimi	600 lt/dk
Hava Giriş Nipeli	1/2"
Hortum Çapı	13.00 mm
Çalışma Basıncı	6.3-8 atü
Ağırlık	9.7 kg
Koli Adedi	1 adet

### OPT-P 317L 1" SOMUN SÖKME



SWING HAMMER	
Uzunluk	430 mm
Civata Çapı	40 mm
Soket Karesi	1"
Max. Tork	2.400 Nm
Boşta Devir	4.200 Rpm
Hava Tüketimi	600 lt/dk
Hava Giriş Nipeli	1/2"
Hortum Çapı	13.00 mm
Çalışma Basıncı	6.3-8 atü
Ağırlık	10.7 kg
Koli Adedi	1 adet

### OPT-P 560 1" SOMUN SÖKME



İKİZ ÇEKİÇ	
Uzunluk	475 mm
Civata Çapı	50 mm
Soket Karesi	1"
Max. Tork	3.661 Nm
Boşta Devir	3.000 Rpm
Hava Tüketimi	425 lt/dk
Hava Giriş Nipeli	1/2"
Hortum Çapı	13.00 mm
Çalışma Basıncı	90-115 psi (6.2-8 atü)
Ağırlık	15.00 kg
Koli Adedi	1 adet

### OPT-P 560L 1" SOMUN SÖKME



İKİZ ÇEKİÇ	
Uzunluk	628 mm
Civata Çapı	50 mm
Soket Karesi	1"
Max. Tork	3.661 Nm
Boşta Devir	3.000 Rpm
Hava Tüketimi	425 lt/dk
Hava Giriş Nipeli	1/2"
Hortum Çapı	13.00 mm
Çalışma Basıncı	90-115 psi (6.2-8 atü)
Ağırlık	16.40 kg
Koli Adedi	1 adet

### OPT-P 318 1" SOMUN SÖKME



İKİZ ÇEKİÇ	
Uzunluk	300 mm
Civata Çapı	45 mm
Soket Karesi	1"
Max. Tork	2.714 Nm
Boşta Devir	3.500 Rpm
Hava Tüketimi	312 lt/dk
Hava Giriş Nipeli	1/2"
Hortum Çapı	13.00 mm
Çalışma Basıncı	90-115 psi (6.2-8 atü)
Ağırlık	9.20 kg
Koli Adedi	2 adet

### OPT-P 318L 1" SOMUN SÖKME



İKİZ ÇEKİÇ	
Uzunluk	450 mm
Civata Çapı	45 mm
Soket Karesi	1"
Max. Tork	2.714 Nm
Boşta Devir	3.500 Rpm
Hava Tüketimi	312 lt/dk
Hava Giriş Nipeli	1/2"
Hortum Çapı	13.00 mm
Çalışma Basıncı	90-115 psi (6.2-8 atü)
Ağırlık	9.70 kg
Koli Adedi	2 adet

### OPT-P 560-12 1.5" SOMUN SÖKME



İKİZ ÇEKİÇ	
Uzunluk	475 mm
Civata Çapı	50 mm
Soket Karesi	1.5"
Max. Tork	4.068 Nm
Boşta Devir	3.000 Rpm
Hava Tüketimi	425 lt/dk
Hava Giriş Nipeli	1/2"
Hortum Çapı	13.00 mm
Çalışma Basıncı	90-115 psi (6.2-8 atü)
Ağırlık	15.05 kg
Koli Adedi	1 adet

### OPT-P 560-12L 1.5" SOMUN SÖKME



İKİZ ÇEKİÇ	
Uzunluk	675 mm
Civata Çapı	50 mm
Soket Karesi	1.5"
Max. Tork	4.068 Nm
Boşta Devir	3.000 Rpm
Hava Tüketimi	425 lt/dk
Hava Giriş Nipeli	1/2"
Hortum Çapı	13.00 mm
Çalışma Basıncı	90-115 psi (6.2-8 atü)
Ağırlık	16.70 kg
Koli Adedi	1 adet



### OPT-P 560-12GX 1.5" SOMUN SÖKME

YENİ



İKİZ ÇEKİÇ	
Uzunluk	490 mm
Civata Çapı	56 mm
Soket Karesi	1,5"
Max. Tork	6779 Nm
Boşta Devir	3000 Rpm
Hava Tüketimi	600 lt/dk
Hava Giriş Nipeli	1/2"
Hortum Çapı	19 mm
Çalışma Basıncı	90 psi (6.2 atü)
Ağırlık	14.90 kg
Koli Adedi	1 adet

### OPT-P 560-12GXL 1.5" SOMUN SÖKME

YENİ



İKİZ ÇEKİÇ	
Uzunluk	625 mm
Civata Çapı	56 mm
Soket Karesi	1,5"
Max. Tork	6779 Nm
Boşta Devir	3000 Rpm
Hava Tüketimi	600 lt/dk
Hava Giriş Nipeli	1/2"
Hortum Çapı	19 mm
Çalışma Basıncı	90 psi (6.2 atü)
Ağırlık	15 kg
Koli Adedi	1 adet

### OPT 367 1/4" CIRCIR MOTORU



1/4" CIRCIR MOTORU	
Uzunluk:	165 mm
Civata Çapı:	8 mm
Soket Karesi:	1/4"
Max. Tork:	36 Nm
Boşta Devir:	240 Rpm
Hava Tüketimi:	80 lt/dk
Hava Giriş Nipeli:	1/4"
Hortum Çapı:	8.00 mm
Çalışma Basıncı:	90 psi (6.2 atü)
Ağırlık:	1.00 kg
Koli Adedi:	20 adet

### OPT 378 3/8" CIRCIR MOTORU



3/8" CIRCIR MOTORU	
Uzunluk:	210 mm
Civata Çapı:	12 mm
Soket Karesi:	3/8"
Max. Tork:	68 Nm
Boşta Devir:	160 Rpm
Hava Tüketimi:	85 lt/dk
Hava Giriş Nipeli:	1/4"
Hortum Çapı:	8.00 mm
Çalışma Basıncı:	90 psi (6.2 atü)
Ağırlık:	1.25 kg
Koli Adedi:	20 adet



### OPT 360K 3/8" CIRCIR MOTORU SET



3/8" CIRCIR MOTORU SET	
Uzunluk:	200 mm
Civata Çapı:	10 mm
Soket Karesi:	3/8"
Max. Tork:	40 Nm
Boşta Devir:	450 Rpm
Hava Tüketimi:	80 lt/dk
Hava Giriş Nipeli:	1/4"
Hortum Çapı:	8.00 mm
Çalışma Basıncı:	90-115 psi (6.2-8.0 atü)
Ağırlık:	0.55 kg
Koli Adedi:	20 adet

### OPT 650B 1/2" CIRCIR MOTORU



1/2" CIRCIR MOTORU	
Uzunluk:	210 mm
Civata Çapı:	12 mm
Soket Karesi:	1/2"
Max. Tork:	78 Nm
Boşta Devir:	165 Rpm
Hava Tüketimi:	90 lt/dk
Hava Giriş Nipeli:	1/4"
Hortum Çapı:	8.00 mm
Çalışma Basıncı:	90 psi (6.2 atü)
Ağırlık:	1.25 kg
Koli Adedi:	20 adet

### OPT-P 450A 1/2" CIRCIR MOTORU



1/2" CIRCIR MOTORU	
Uzunluk:	210 mm
Civata Çapı:	12 mm
Soket Karesi:	1/2"
Max. Tork:	68 Nm
Boşta Devir:	150 Rpm
Hava Tüketimi:	125 lt/dk
Hava Giriş Nipeli:	1/4"
Hortum Çapı:	8.00 mm
Çalışma Basıncı:	90 psi (6.2 atü)
Ağırlık:	1.20 kg
Koli Adedi:	20 adet

### OPT-P 388 1/2" CIRCIR MOTORU



1/2" CIRCIR MOTORU	
Uzunluk:	360 mm
Civata Çapı:	12 mm
Soket Karesi:	1/2"
Max. Tork:	122 Nm
Boşta Devir:	150 Rpm
Hava Tüketimi:	90 lt/dk
Hava Giriş Nipeli:	1/4"
Hortum Çapı:	9.50 mm
Çalışma Basıncı:	90 psi (6.2 atü)
Ağırlık:	1.50 kg
Koli Adedi:	10 adet



### OPT-P 450C 1/2" SOMUN SÖKME 90°



#### 1/2" SOMUN SÖKME 90°

Uzunluk	335 mm
Civata Çapı	16 mm
Soket Karesi	1/2"
Max. Tork	280 Nm
Boşta Devir	6.000 Rpm
Hava Tüketimi	175 lt/dk
Hava Giriş Nipeli	1/4"
Hortum Çapı	10.00 mm
Çalışma Basıncı	6.3-8.0 atü
Ağırlık	2.0 kg
Koli Adedi	10 adet

### OPT-P 398 1/2" SOMUN SÖKME 90°



#### 1/2" SOMUN SÖKME 90°

Uzunluk	350 mm
Civata Çapı	10 mm
Soket Karesi	1/2"
Max. Tork	240 Nm
Boşta Devir	3.500 Rpm
Hava Tüketimi	220 lt/dk
Hava Giriş Nipeli	1/4"
Hortum Çapı	10.00 mm
Çalışma Basıncı	90-115 psi (6.2-8.0 atü)
Ağırlık	2.0 kg
Koli Adedi	10 adet

### OPT 232 10 MM MATKAP SAĞ-SOL



#### 10 MM MATKAP SAĞ-SOL

Uzunluk	177 mm
Mandren Kap.	10 mm
Mandren Ba.	3/8 24 UNF
Boşta Devir	1800 Rpm
Hava Tüketimi	270 lt/dk
Hava Giriş Nipeli	1/4"
Hortum Çapı	10.00 mm
Çalışma Basıncı	90 psi (6.2 atü)
Ağırlık	1.30 kg
Koli Adedi	10 adet

### OPT 230 10 MM MATKAP



#### 10 MM MATKAP

Uzunluk	177 mm
Mandren Kap.	10 mm
Mandren Ba.	3/8 24 UNF
Boşta Devir	2.200 Rpm
Hava Tüketimi	270 lt/dk
Hava Giriş Nipeli	1/4"
Hortum Çapı	10.00 mm
Çalışma Basıncı	90 psi (6.2 atü)
Ağırlık	1.30 kg
Koli Adedi	10 adet

### OPC 55214 1/2" CIRCIR MOTORU



#### 1/2" CIRCIR MOTORU

Uzunluk	266 mm
Civata Çapı	12 mm
Soket Karesi	1/2"
Max. Tork	70 Nm
Boşta Devir	300 Rpm
Hava Tüketimi	180 lt/dk
Hava Giriş Nipeli	1/4"
Hortum Çapı	10.00 mm
Çalışma Basıncı	90-115 psi (6.2-8.0 atü)
Ağırlık	0.88 kg
Koli Adedi	20 adet

### OSA-TW2030 DİJİTAL TORK KOLU 1/4"



#### Dijital Tork Kolu 1/4"

1/4" 3-20 Nm dijital tork kolu  
Uzunluk 223 mm

### OPC 20202 10 MM MATKAP



#### 10 MM MATKAP SAĞ-SOL

Uzunluk	176 mm
Mandren Kap.	10 mm
Mandren Ba.	3/8 24 UNF
Boşta Devir	1.500 Rpm
Ses şiddeti	83 dB (A)
Hava Tüketimi	150 lt/dk
Hava Giriş Nipeli	1/4"
Hortum Çapı	10.00 mm
Güç	0.30 kW
Çalışma Basıncı	90-115psi (6.2-8.0 atü)
Ağırlık	1.39 kg
Koli Adedi	10 adet

### OPT 237 13 MM MATKAP SAĞ-SOL



#### 13 MM MATKAP SAĞ-SOL

Uzunluk	203 mm
Mandren Kap.	13 mm
Mandren Ba.	3/8 24 UNF
Boşta Devir	400 Rpm
Hava Tüketimi	250 lt/dk
Hava Giriş Nipeli	1/4"
Hortum Çapı	10.00 mm
Çalışma Basıncı	90 psi (6.2 atü)
Ağırlık	1.76 kg
Koli Adedi	10 adet

### OSA-TW3135 DİJİTAL TORK KOLU 3/8"



#### Dijital Tork Kolu 3/8"

3/8" 10-135 Nm dijital tork kolu  
Uzunluk 400 mm

### OSA-TW4340 DİJİTAL TORK KOLU 1/2"



#### Dijital Tork Kolu 1/2"

1/2" 34-340 Nm dijital tork kolu  
Uzunluk 770 mm

### OPT-P 130 6.5 MM MATKAP



#### 6.5 MM MATKAP

Uzunluk	170 mm
Mandren Kap.	6.5 mm
Mandren Ba.	3/8 24 UNF
Güç	0.20 kW
Boşta Devir	4.000 Rpm
Hava Tüketimi	120 lt/dk
Hava Giriş Nipeli	1/4"
Hortum Çapı	8.00 mm
Çalışma Basıncı	90 psi (6.2 atü)
Ağırlık	0.90 kg
Koli Adedi	20 adet

### OPT 709-R 10 MM MATKAP 90°



#### 10 MM MATKAP 90°

Uzunluk	210 mm
Yükseklik	90 mm
Mandren Kap.	10 mm
Mandren Ba.	3/8 24 UNF
Boşta Devir	1.500 Rpm
Hava Tüketimi	113 lt/dk
Hava Giriş Nipeli	1/4"
Hortum Çapı	10.00 mm
Çalışma Basıncı	90 psi (6.2 atü)
Ağırlık	1.10 kg
Koli Adedi	10 adet



### OPT 113 10 MM MATKAP



10 MM MATKAP	
Uzunluk:	210 mm
Mandren Kap.:	10 mm
Mandren Ba.:	3/8 24 UNF
Boşta Devir:	4.500 Rpm
Hava Tüketimi:	210 lt/dk
Hava Giriş Nipeli:	1/4"
Hortum Çapı:	10.00 mm
Çalışma Basıncı:	90 psi (6.2 atü)
Ağırlık:	1.20 kg
Koli Adedi:	10 adet

### OPT 208 6.5 MM MATKAP



6.5 MM MATKAP	
Uzunluk:	150 mm
Mandren Kap.:	6.5 mm
Mandren Ba.:	3/8 24 UNF
Boşta Devir:	6.500 Rpm
Hava Tüketimi:	170 lt/dk
Hava Giriş Nipeli:	1/4"
Hortum Çapı:	10.00 mm
Çalışma Basıncı:	90 psi (6.2 atü)
Ağırlık:	0.60 kg
Koli Adedi:	20 adet

### OPT 4080-6 TORNAVİDA



TORNAVİDA	
Uzunluk:	190 mm
Soket Karesi:	1/4"
Vida Çapı:	6 mm
Max. Tork:	4-8 Nm
Boşta Devir:	1.800 Rpm
Hava Tüketimi:	170 lt/dk
Hava Giriş Nipeli:	1/4"
Hortum Çapı:	9.50 mm
Çalışma Basıncı:	90 psi (6.2 atü)
Ağırlık:	1.10 kg
Koli Adedi:	10 adet

### OPT 4080-8 TORNAVİDA



TORNAVİDA	
Uzunluk:	216 mm
Soket Karesi:	1/4"
Vida Çapı:	8 mm
Max. Tork:	4-11 Nm
Boşta Devir:	800 Rpm
Hava Tüketimi:	170 lt/dk
Hava Giriş Nipeli:	1/4"
Hortum Çapı:	9.50 mm
Çalışma Basıncı:	90 psi (6.2 atü)
Ağırlık:	1.30 kg
Koli Adedi:	10 adet

### OPT 239 16 MM MATKAP



16 MM MATKAP SAĞ-SOL	
Uzunluk:	328 mm
Mandren Kap.:	16 mm
Mandren Ba.:	1/2 20 UNF
Boşta Devir:	800 Rpm
Hava Tüketimi:	350 lt/dk
Hava Giriş Nipeli:	3/8"
Hortum Çapı:	13.00 mm
Çalışma Basıncı:	90 psi (6.2 atü)
Ağırlık:	3.6 kg
Koli Adedi:	4 adet

### OPT-P 766 TORNAVİDA



DIŞTAN TORKLU TORNAVİDA	
Uzunluk:	230 mm
Soket Karesi:	1/4"
Vida Çapı:	6 mm
Max. Tork:	9 Nm
Boşta Devir:	1.800 Rpm
Hava Tüketimi:	170 lt/dk
Hava Giriş Nipeli:	1/4"
Hortum Çapı:	9.50 mm
Çalışma Basıncı:	90 psi (6.2 atü)
Ağırlık:	1.33 kg
Koli Adedi:	10 adet

### OPT-P 768 TORNAVİDA



DIŞTAN TORKLU TORNAVİDA	
Uzunluk:	250 mm
Soket Karesi:	1/4"
Vida Çapı:	8 mm
Max. Tork:	12 Nm
Boşta Devir:	800 Rpm
Hava Tüketimi:	170 lt/dk
Hava Giriş Nipeli:	1/4"
Hortum Çapı:	9.50 mm
Çalışma Basıncı:	90 psi (6.2 atü)
Ağırlık:	1.43 kg
Koli Adedi:	10 adet

### OPT-P 4250 TORNAVİDA ÇEKİÇLİ



TORNAVİDA ÇEKİÇLİ	
Uzunluk:	170 mm
Soket Karesi:	1/4"
Vida Çapı:	8 mm
Max. Tork:	50 Nm
Boşta Devir:	3.000 Rpm
Hava Tüketimi:	280 lt/dk
Hava Giriş Nipeli:	1/4"
Hortum Çapı:	9.50 mm
Çalışma Basıncı:	90 psi (6.2 atü)
Ağırlık:	1.10 kg
Koli Adedi:	20 adet

### OPC 48116 TORNAVİDA



TORNAVİDA ÇEKİÇLİ	
Uzunluk:	140 mm
Soket Kap.:	1/4"
Vida Çapı:	6 mm
Max. Tork:	40 Nm
Boşta Devir:	12.000 Rpm
Hava Tüketimi:	190 lt/dk
Hava Giriş Nipeli:	1/4"
Hortum Çapı:	8.00 mm
Çalışma Basıncı:	90 psi (6.2 atü)
Ağırlık:	0.90 kg
Koli Adedi:	20 adet



### OPC 44204 TORNAVİDA



DIŐTAN TORKLU TORNAVİDA	
Uzunluk:	180 mm
Soket Karesi:	1/4"
Vida Çapı:	2.2-4.2 mm
Tork:	0.2-1.5 Nm
BoŐta Devir:	2.200 Rpm
Hava Tüketimi:	280 lt/dk
Hava GiriŐ Nipeli:	1/4"
Hortum Çapı:	9.50 mm
ÇalıŐma Basıncı:	90 psi (6.2 atü)
Ağırlık:	0.43 kg
Koli Adedi:	8 adet

### OPC 44205 TORNAVİDA



DIŐTAN TORKLU TORNAVİDA	
Uzunluk:	180 mm
Soket Karesi:	1/4"
Vida Çapı:	2.8-5.0 mm
Tork:	0.48-2.9 Nm
BoŐta Devir:	1.000 Rpm
Hava Tüketimi:	280 lt/dk
Hava GiriŐ Nipeli:	1/4"
Hortum Çapı:	9.50 mm
ÇalıŐma Basıncı:	90 psi (6.2 atü)
Ağırlık:	0.43 kg
Koli Adedi:	8 adet

### OPC 44206 TORNAVİDA



DIŐTAN TORKLU TORNAVİDA	
Uzunluk:	215 mm
Soket Karesi:	1/4"
Vida Çapı:	2.9-6.0 mm
Tork:	0.7-5.0 Nm
BoŐta Devir:	1.400 Rpm
Hava Tüketimi:	300 lt/dk
Hava GiriŐ Nipeli:	1/4"
Hortum Çapı:	9.50 mm
ÇalıŐma Basıncı:	90 psi (6.2 atü)
Ağırlık:	0.77 kg
Koli Adedi:	8 adet

### OPC 44208 TORNAVİDA



DIŐTAN TORKLU TORNAVİDA	
Uzunluk:	215 mm
Soket Karesi:	1/4"
Vida Çapı:	4.1-7.0 mm
Tork:	1.5-9.3 Nm
BoŐta Devir:	550 Rpm
Hava Tüketimi:	300 lt/dk
Hava GiriŐ Nipeli:	1/4"
Hortum Çapı:	9.50 mm
ÇalıŐma Basıncı:	90 psi (6.2 atü)
Ağırlık:	0.77 kg
Koli Adedi:	8 adet

### OPT-P 726 TORNAVİDA



DIŐTAN TORKLU TORNAVİDA	
Uzunluk:	250 mm
Soket Karesi:	1/4"
Vida Çapı:	6 mm
Max. Tork:	8 Nm
BoŐta Devir:	1.800 Rpm
Hava Tüketimi:	170 lt/dk
Hava GiriŐ Nipeli:	1/4"
Hortum Çapı:	9.50 mm
ÇalıŐma Basıncı:	90 psi (6.2 atü)
Ağırlık:	1.00 kg
Koli Adedi:	20 adet

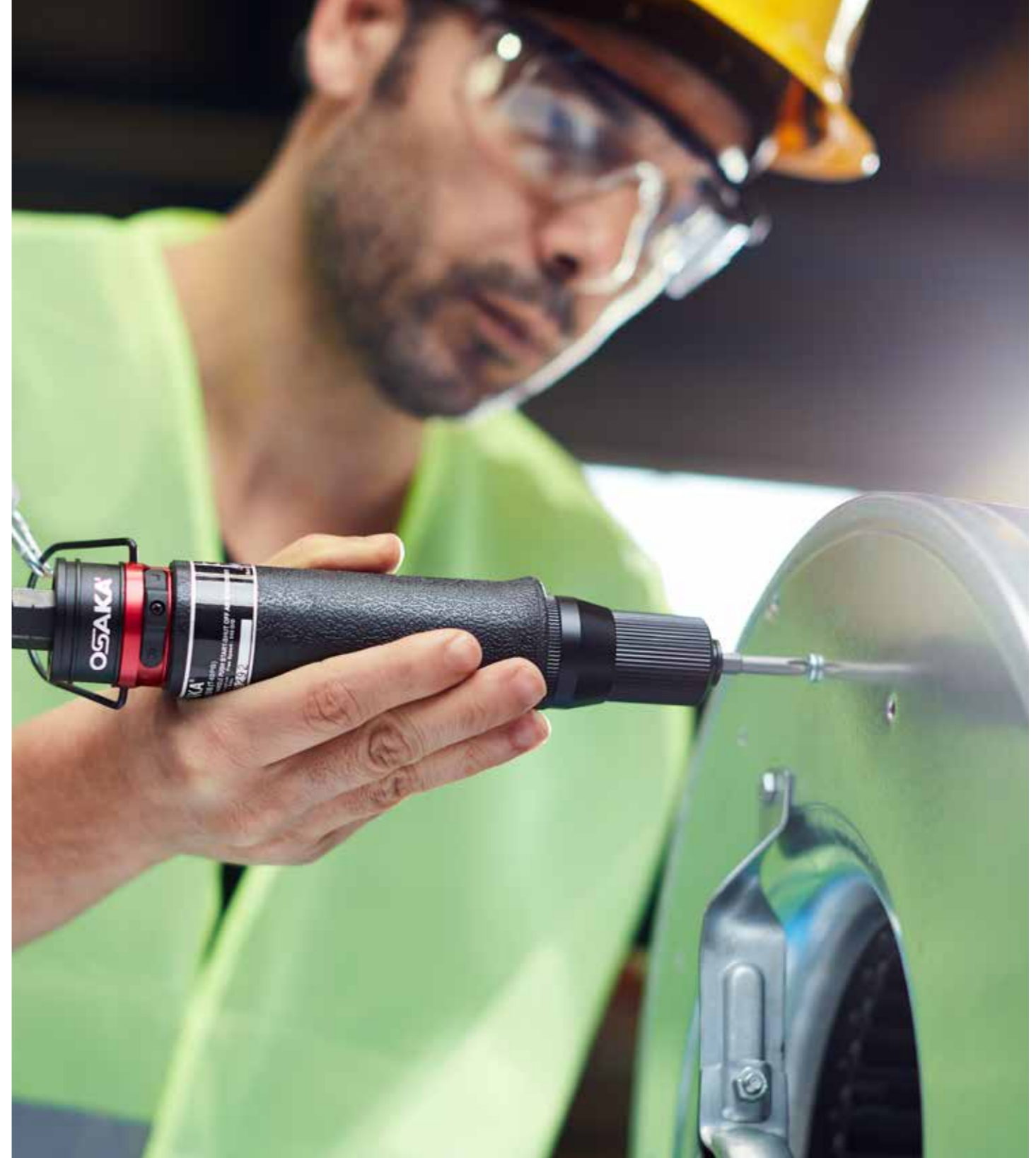



### OPT 4080-D TORNAVİDA



#### TORNAVİDA DIRECT DRIVE

Uzunluk:	183 mm
Soket Karesi:	1/4"
Vida Çapı:	6 mm
Max. Tork:	9 Nm
Boşta Devir:	2.600 Rpm
Hava Tüketimi:	270 lt/dk
Hava Giriş Nipeli:	1/4"
Hortum Çapı:	9.50 mm
Çalışma Basıncı:	90 psi (6.2 atü)
Ağırlık:	1.10 kg
Koli Adedi:	10 adet

### OPT 402 TORNAVİDA



#### TORNAVİDA ÇEKİÇLİ

Uzunluk:	187 mm
Soket Karesi:	1/4"
Vida Çapı:	5 mm
Max. Tork:	6 Nm
Boşta Devir:	10.000 Rpm
Hava Tüketimi:	125 lt/dk
Hava Giriş Nipeli:	1/4"
Hortum Çapı:	9.50 mm
Çalışma Basıncı:	90 psi (6.2 atü)
Ağırlık:	0.90 kg
Koli Adedi:	20 adet

### OPC 21808 KILAVUZ ÇEKME



#### KILAVUZ ÇEKME

Uzunluk:	166 mm
Pens Çapı:	3-8 mm
Max. Tork:	20 Nm
Boşta Devir:	500 Rpm
Hava Tüketimi:	150 lt/dk
Hava Giriş Nipeli:	3/8"
Hortum Çapı:	13.00 mm
Çalışma Basıncı:	90 psi (6.2 atü)
Ağırlık:	1.80 kg
Standart Aksesuar:	M8 Pens
Koli Adedi:	4 adet

### OPC 21812 KILAVUZ ÇEKME



#### KILAVUZ ÇEKME

Uzunluk:	195 mm
Pens Çapı:	3-12 mm
Max. Tork:	50 Nm
Boşta Devir:	300 Rpm
Hava Tüketimi:	220 lt/dk
Hava Giriş Nipeli:	3/8"
Hortum Çapı:	13.00 mm
Çalışma Basıncı:	90 psi (6.2 atü)
Ağırlık:	3.00 kg
Standart Aksesuar:	M12 Pens
Koli Adedi:	4 adet

### OPT 842 TORNAVİDA



#### TORNAVİDA

Uzunluk:	230 mm
Soket Karesi:	1/4"
Vida Çapı:	6 mm
Max. Tork:	4-8 Nm
Boşta Devir:	1.800 Rpm
Hava Tüketimi:	170 lt/dk
Hava Giriş Nipeli:	1/4"
Hortum Çapı:	9.50 mm
Çalışma Basıncı:	90 psi (6.2 atü)
Ağırlık:	1.16 kg
Koli Adedi:	10 adet

### OPT 843 TORNAVİDA



#### TORNAVİDA

Uzunluk:	240 mm
Soket Karesi:	1/4"
Vida Çapı:	8 mm
Max. Tork:	4-11 Nm
Boşta Devir:	800 Rpm
Hava Tüketimi:	110 lt/dk
Hava Giriş Nipeli:	1/4"
Hortum Çapı:	9.50 mm
Çalışma Basıncı:	90 psi (6.2 atü)
Ağırlık:	1.26 kg
Koli Adedi:	10 adet

### OPT-P KC 12-3 KILAVUZ ÇEKME



#### KILAVUZ ÇEKME

Uzunluk:	200 mm
Pens Çapı:	3-12 mm
Boşta Devir:	400 Rpm
Hava Tüketimi:	240 lt/dk
Hava Giriş Nipeli:	1/4"
Hortum Çapı:	11.00 mm
Çalışma Basıncı:	90 psi (6.2 atü)
Ağırlık:	2.00 kg
Koli Adedi:	1 adet
Ağırlık:	0.43 kg
Koli Adedi:	8 adet

### OPT-P KC 16-3 KILAVUZ ÇEKME



#### KILAVUZ ÇEKME

Uzunluk:	200 mm
Pens Çapı:	3-16 mm
Boşta Devir:	300 Rpm
Hava Tüketimi:	285 lt/dk
Hava Giriş Nipeli:	3/8"
Hortum Çapı:	11.00 mm
Çalışma Basıncı:	90 psi (6.2 atü)
Ağırlık:	2.40 kg
Koli Adedi:	1 adet
Ağırlık:	0.77 kg
Koli Adedi:	8 adet

### OPT 304 TORNAVİDA



#### TORNAVİDA

Uzunluk:	235 mm
Soket Karesi:	1/4"
Vida Çapı:	4 mm
Max. Tork:	1.3-2.4 Nm
Boşta Devir:	1.500 Rpm
Hava Tüketimi:	113 lt/dk
Hava Giriş Nipeli:	1/4"
Hortum Çapı:	8.00 mm
Çalışma Basıncı:	90 psi (6.2 atü)
Ağırlık:	0.66 kg
Koli Adedi:	10 adet

### OPT 304-B TORNAVİDA



PUSH-START

#### PUSH-START TORNAVİDA

Uzunluk:	230 mm
Soket Karesi:	1/4"
Vida Çapı:	5 mm
Max. Tork:	1.3-2.4 Nm
Boşta Devir:	1.500 Rpm
Hava Tüketimi:	130 lt/dk
Hava Giriş Nipeli:	1/4"
Hortum Çapı:	9.50 mm
Çalışma Basıncı:	90 psi (6.2 atü)
Ağırlık:	0.60 kg
Koli Adedi:	10 adet

### OPT-P KC 22-4 KILAVUZ ÇEKME



#### KILAVUZ ÇEKME

Uzunluk:	200 mm
Pens Çapı:	4-22 mm
Boşta Devir:	120-300 Rpm
Hava Tüketimi:	285 lt/dk
Hava Giriş Nipeli:	3/8"
Hortum Çapı:	11.00 mm
Çalışma Basıncı:	90 psi (6.2 atü)
Ağırlık:	2.90 kg
Koli Adedi:	1 adet
Ağırlık:	0.77 kg
Koli Adedi:	8 adet





### OPT-P 3-12K KILAVUZ ÇEKME

KILAVUZ ÇEKME	
Kapasite:	M3-M12
Devir:	400 Rpm
Çalışma mesafesi:	Rmax=1400 mm Rmin=200 mm
Ağırlık:	18 kg

#### Standart aksesuarlar

- Havalı kılavuz çekme mili
- Paralel kol
- Masa montaj kolonu
- Şartlandırıcı
- Radyal vinç kolu-kol erişimini 500 mm yükseltir
- Yedek pens: M3-M4-M6-M8-M10-M12 a



### OPT-P 3-16K KILAVUZ ÇEKME

KILAVUZ ÇEKME	
Kapasite:	M3-M16
Devir:	300 Rpm
Çalışma mesafesi:	Rmax=1400 mm Rmin=200 mm
Ağırlık:	20 kg

#### Standart aksesuarlar

- Havalı kılavuz çekme mili
- Paralel kol
- Masa montaj kolonu
- Şartlandırıcı
- Radyal vinç kolu-kol erişimini 500 mm yükseltir
- Yedek pens: M6-M8-M10-M12-M14-M16



### OPT-P 4-22K KILAVUZ ÇEKME

KILAVUZ ÇEKME	
Kapasite:	M4-M22
Devir:	120-300 Rpm
Çalışma mesafesi:	Rmax=1400 mm Rmin=200 mm
Ağırlık:	22 kg

#### Standart aksesuarlar

- Havalı kılavuz çekme mili
- Paralel kol
- Masa montaj kolonu
- Şartlandırıcı
- Radyal vinç kolu-kol erişimini 500 mm yükseltir
- Yedek pens: M6-M8-M10-M12-M14-M16

### OPT-P 3-16K 90° KILAVUZ ÇEKME



KILAVUZ ÇEKME	
Kapasite:	M3-M16
Devir:	300 Rpm
Çalışma mesafesi:	Rmax=1400 mm Rmin=200 mm
Ağırlık:	20 kg

#### Standart aksesuarlar

- Havalı kılavuz çekme mili
- Paralel kol
- Masa montaj kolonu
- Şartlandırıcı
- Radyal vinç kolu-kol erişimini 500 mm yükseltir
- 90° Dönebilme Yeteneği
- Yedek pens: M6-M8-M10-M12-M14-M16

### OPT-P HM32-K KILAVUZ ÇEKME



KILAVUZ ÇEKME	
Kapasite:	M4-M32
Devir:	0-200 Rpm
Ağırlık:	22 kg
Motor:	5 HP
Hidrolik Basınç:	140 Bar
Elektrik Girişi:	3mx380 V/50 Hz
Koli Adedi:	1 adet

#### Standart aksesuarlar

- Hidrolik kılavuz çekme mili
- Paralel kol
- Masa montaj kolonu
- 6 adet kılavuz mili
- Hidrolik motor-hidrolik pompa hidrolik kasa
- Elektrik kontrol devresi

### OPT-P 4-22K 90° KILAVUZ ÇEKME



KILAVUZ ÇEKME	
Kapasite:	M4-M22
Devir:	120-300 Rpm
Çalışma mesafesi:	Rmax=1400 mm Rmin=200 mm
Ağırlık:	22 kg

#### Standart aksesuarlar

- Havalı kılavuz çekme mili
- Paralel kol
- Masa montaj kolonu
- Şartlandırıcı
- Radyal vinç kolu-kol erişimini 500 mm yükseltir
- 90° Dönebilme Yeteneği
- Yedek pens: M6-M8-M10-M12-M14-M16

### OSI 570 PARALEL KOL

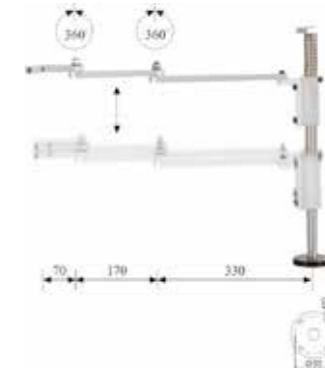

PARALEL KOL	
Kol uzunluğu	570 mm

### OSI 790 PARALEL KOL

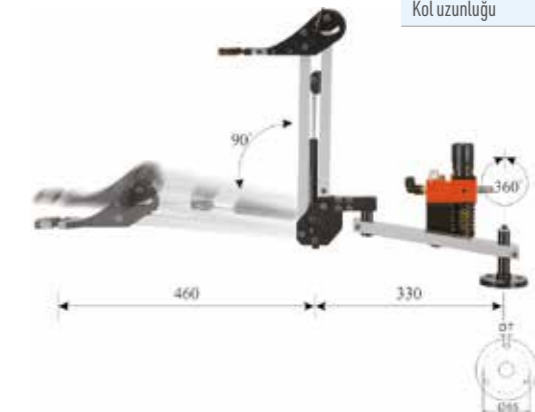

PARALEL KOL	
Kol uzunluğu	790 mm



### OPT 86032 ÇİVİ ÇAKMA 32 MM

YENİ



Çivi Ölçüsü:	10-32 mm
Ebat:	240x60x165 mm
Uzunluk:	220 mm
Hava Basıncı:	5-7 bar
Ağırlık:	125 kg

### OPT 86050 ÇİVİ ÇAKMA 50MM



ÇİVİ ÇAKMA	
Ağırlık:	1.38 kg
Ebat:	250x238x57 mm
Kapasite:	100 adet
Hava Basıncı:	5-7 kgf/cm <sup>2</sup>
Uzunluk:	20x50 mm
Genişlik ve Kalınlık:	1,27x1,05 mm
Uygulamalar:	Palet, ahşap kutu, Palet, ahşap kutu, sandık, zemin, siding, döşeme ve kaplama, mobilya sanayii

### OPT 8016 DÖŞEME TABANCASI



DÖŞEME / ZIMBA TABANCASI	
Uzunluk:	240 mm
Tel Ölçüsü:	8X4-8X16
Hava Tüketimi:	60 lt/dk
Hava Giriş Nipeli:	1/4"
Hortum Çapı:	8.00 mm
Çalışma Basıncı:	90 psi (6.2 atü)
Ağırlık:	1.00 kg
Koli Adedi:	10 adet

### OPT-P 85135 MEKANİK KOLİ KAPAMA TABANCASI



Zimba Tel Ölçüsü	
Yükseklik:	15 18 mm
Boy:	34,7 mm
Makina Ölçüsü	
Uzunluk:	360 mm
Yükseklik:	335 mm
En:	174 mm
Ağırlık:	6,00 kg

### OPT 86055 ÇİVİ ÇAKMA 55MM



ÇİVİ ÇAKMA	
Ağırlık:	2.75 kg
Ebat:	270x283x131 mm
Kapasite:	300-400 adet
Hava Basıncı:	6-8 kgf/cm <sup>2</sup>
Çivi Tipi:	15° telli kaynak çivi rulo
En:	115 mm
Çivi Çapı:	2.1-2.3 mm
Kafa Çapı:	5.0-5.7 mm (.197"- .224")
Uzunluk:	25-57 mm (1" - 2-1/4")
Uygulamalar:	Palet, ahşap kutu, Palet, ahşap kutu, sandık, zemin, siding, döşeme ve kaplama,

### OPT 86064 ÇİVİ ÇAKMA 64MM



ÇİVİ ÇAKMA	
Ağırlık:	3.01 kg
Ebat:	318x267x95 mm
Kapasite:	100 adet
Hava Basıncı:	5-7 kgf/cm <sup>2</sup>
Uzunluk:	18-64 mm
Genişlik ve Kalınlık:	2.2 mm
Uygulamalar:	İnşaat çerçeveleme, ahşap çivileme, kafes, sandık kutu montajı, Mobilya sanayii

### OPT-P 85235 HAVALI KOLİ KAPAMA MAKİNASI



Zimba Tel Ölçüsü	
Yükseklik:	15-18 mm
Boy:	34,7 mm
Makina	
Uzunluk:	300 mm
Yükseklik:	200 mm
En:	100 mm
Ağırlık:	1.59 kg
Hortum Çapı:	8 mm
Çalışma Basıncı:	5-7 bar

### OPT-P 85335 HAVALI KOLİ KAPAMA MAKİNASI



Zimba Tel Ölçüsü	
Yükseklik:	15-18mm
Boy:	34,7 mm
Makina	
Uzunluk:	415 mm
Yükseklik:	220 mm
En:	115 mm
Ağırlık:	2.65 kg
Hortum Çapı:	8 mm
Çalışma Basıncı:	5-7 bar

### OPT 86070 ÇİVİ ÇAKMA 70MM



ÇİVİ ÇAKMA	
Ağırlık:	3.80 kg
Ebat:	336x143x318 mm
Kapasite:	300 adet
Hava Basıncı:	6-8 kgf/cm <sup>2</sup>
Çivi Tipi:	15° telli kaynak çivi rulo
Çivi Çapı:	2.3-2.9 mm (.090"- .113")
Kafa Çapı:	5.7-7.0 mm (.224"- .276")
Uzunluk:	45-70 mm (1-3/4"- 2-3/4")
Uygulamalar:	Palet, ahşap kutu, sandık, zemin, siding, döşeme ve kaplama,

### OPT 86090 ÇİVİ ÇAKMA 90MM



ÇİVİ ÇAKMA	
Ağırlık:	4.20 kg
Ebat:	347x137x348 mm
Kapasite:	300 adet
Hava Basıncı:	6-8 kgf/cm <sup>2</sup>
Çivi Tipi:	15° telli kaynak çivi rulo
Çivi Çapı:	2.5-3.8 mm (.099"- .148")
Kafa Çapı:	6.5-7.7 mm (.256"- .303")
Uzunluk:	45-90 mm (1-3/4"- 3-1/2")
Uygulamalar:	Palet, ahşap kutu, sandık, zemin, siding, döşeme ve kaplama,

### OPT-P 85435 HAVALI KOLİ KAPAMA MAKİNASI



Zimba Tel Ölçüsü	
Yükseklik:	18-22 mm
Boy:	34,7 mm
Makina	
Uzunluk:	415 mm
Yükseklik:	220 mm
En:	115 mm
Ağırlık:	2.65 kg
Hortum Çapı:	8 mm
Çalışma Basıncı:	5-7 bar

### OPT-P 85735J JUMBO TİP KOLİ KAPAMA



Zimba Tel Ölçüsü	
Yükseklik:	32-35 mm
Boy:	32 mm
Makina	
Uzunluk:	360 mm
Yükseklik:	335 mm
En:	174 mm
Ağırlık:	6.00 kg
Hortum Çapı:	8 mm
Çalışma Basıncı:	5-7 bar



## OPT 1005 YANKESKİ



YANKESKİ	
Uzunluk:	140 mm
Kesme Kapasitesi:	Demir 0.50 mm Bakır 1.00 mm Alüminyum 1.26 mm
Stroke:	10.0 mm
Hortum Çapı:	9.50 mm
Hava Giriş Nipeli:	1/4"
Hava Tüketimi:	85 lt/dk
Çalışma Basıncı:	90 psi (6.2 atü)
Ağırlık:	0.14 kg
Koli Adedi:	20 adet

## OPT 1006 YANKESKİ



YANKESKİ	
Uzunluk:	160 mm
Kesme Kapasitesi:	Demir 1.00 mm Bakır 1.60 mm Alüminyum 2.26 mm
Stroke:	10.0 mm
Hortum Çapı:	9.50 mm
Hava Giriş Nipeli:	1/4"
Hava Tüketimi:	95 lt/dk
Çalışma Basıncı:	90 psi (6.2 atü)
Ağırlık:	0.20 kg
Koli Adedi:	20 adet

## OPT-P 690 NİBLER SAC KESME



NİBLER SAC KESME	
Uzunluk:	150 mm
Kesme Kapasitesi:	Çelik 1.20 mm Sac 1.60 mm Alüminyum 2.00 mm
Kesme Hızı:	2.6 m/dk
Hortum Çapı:	9.50 mm
Hava Giriş Nipeli:	1/4"
Hava Tüketimi:	113 lt/dk
Çalışma Basıncı:	90 psi (6.2 atü)
Ağırlık:	1.20 kg
Koli Adedi:	20 adet

## OPT 216 CAM FİTLİ KESME



CAM FİTLİ KESME	
Uzunluk:	200 mm
Stroke:	3.00
Stroke Sayısı:	20.000 d/dk
Hortum Çapı:	9.50 mm
Hava Giriş Nipeli:	1/4"
Hava Tüketimi:	260 lt/dk
Çalışma Basıncı:	90 psi (6.2 atü)
Ağırlık:	0.20 kg
Koli Adedi:	20 adet

## OPT 1007 YANKESKİ



YANKESKİ	
Uzunluk:	200 mm
Kesme Kapasitesi:	Demir 2.00 mm Bakır 2.60 mm Alüminyum 3.26 mm
Stroke:	10.0 mm
Hortum Çapı:	9.50 mm
Hava Giriş Nipeli:	1/4"
Hava Tüketimi:	105 lt/dk
Çalışma Basıncı:	90 psi (6.2 atü)
Ağırlık:	0.35 kg
Koli Adedi:	10 adet

## OPT 1008 YANKESKİ



YANKESKİ	
Uzunluk:	240 mm
Kesme Kapasitesi:	Demir 2.90 mm Bakır 3.30 mm Alüminyum 3.26 mm Paslanmaz 2.00 mm
Stroke:	10.0 mm
Hortum Çapı:	9.50 mm
Hava Giriş Nipeli:	1/4"
Hava Tüketimi:	125 lt/dk
Çalışma Basıncı:	90 psi (6.2 atü)
Ağırlık:	0.56 kg
Koli Adedi:	10 adet

## OPT 315 EĞE MOTORU



EĞE MOTORU	
Uzunluk:	165 mm
Stroke:	9.0 mm
Stroke Sayısı:	3.700 spm
Hava Tüketimi:	170 lt/dk
Hava Giriş Nipeli:	1/4"
Hortum Çapı:	9.50 mm
Çalışma Basıncı:	90 psi (6.2 atü)
Ağırlık:	1.51 kg
Koli Adedi:	20 adet

## OPT-P 940 ÇELİK KALEM



YAZI YAZMA	
Uzunluk:	170 mm
Stroke:	1.2 mm
Boşta Darbe:	42.000 bpm
Hava Tüketimi:	60 lt/dk
Hava Giriş Nipeli:	1/4"
Hortum Çapı:	8.00 mm
Çalışma Basıncı:	90-115 psi (6.2-8.0 atü)
Ağırlık:	0.20 kg
Koli Adedi:	20 adet

## OPT 310 SAC KESME



SAC KESME	
Uzunluk:	290 mm
Kesme Kapasitesi:	Çelik 1.20 mm Alüminyum 1.60 mm
Boşta Devir:	2.600 Rpm
Hortum Çapı:	9.50 mm
Hava Giriş Nipeli:	1/4"
Hava Tüketimi:	113 lt/dk
Çalışma Basıncı:	90 psi (6.2 atü)
Ağırlık:	1.05 kg
Koli Adedi:	10 adet

## OPT 330 SAC KESME



SAC KESME	
Uzunluk:	290 mm
Kesme Kapasitesi:	Çelik 1.20 mm Alüminyum 1.60 mm
Boşta Devir:	2.600 Rpm
Hortum Çapı:	9.50 mm
Hava Giriş Nipeli:	1/4"
Hava Tüketimi:	113 lt/dk
Çalışma Basıncı:	90 psi (6.2 atü)
Ağırlık:	1.15 kg
Koli Adedi:	10 adet

## OPT-P 200 ÇELİK ÇEMBER MAKİNASI



Sıkıştırma Torku:	4.000 Nm
Ebat:	315X145X127 mm
Çember Genişliği:	19 mm Maks.
Çember Kalınlığı:	0.38mm-0.63mm
Sıkıştırma:	55%
Hava Tüketimi:	180 lt/dk
Hava Giriş Nipeli:	1/4"
Hortum Çapı:	10 mm
Çalışma Basıncı:	90-115 psi (6.2-8.0 atü)
Ağırlık:	4.85 kg
Koli Adedi:	6 adet



### OPC 61119 KALIPÇI TAŞLAMA



KALIPÇI TAŞLAMA	
Uzunluk:	190 mm
Pens Çapı:	6 mm
Taş Çapı:	30 mm
Güç:	0.20 kW
Boşta Devir:	18.000 Rpm
Hava Tüketimi:	220 lt/dk
Hava Giriş Nipeli:	1/4"
Hortum Çapı:	10.00 mm
Çalışma Basıncı:	90 psi (6.2 atü)
Ağırlık:	0.40 kg
Koli Adedi:	50 adet

### OPT-P 128 KALIPÇI TAŞLAMA



KALIPÇI TAŞLAMA	
Uzunluk:	156 mm
Pens Çapı:	6 mm
Taş Çapı:	32 mm
Boşta Devir:	22.000 Rpm
Hava Tüketimi:	300 lt/dk
Hava Giriş:	1/4"
Hortum Çapı:	8.00 mm
Çalışma Basıncı:	90 psi (6.2 atü)
Ağırlık:	0.7 kg
Koli Adedi:	10 adet

### OPT 126 KABZALI KALIPÇI TAŞLAMA



KALIPÇI TAŞLAMA	
Uzunluk:	190 mm
Pens Çapı:	6 mm
Taş Çapı:	30 mm
Güç:	0.20 kW
Boşta Devir:	18.000 Rpm
Hava Tüketimi:	220 lt/dk
Hava Giriş Nipeli:	1/4"
Hortum Çapı:	10.00 mm
Çalışma Basıncı:	90 psi (6.2 atü)
Ağırlık:	0.40 kg
Koli Adedi:	50 adet

### OPT 124 KALIPÇI TAŞLAMA 90°



KALIPÇI TAŞLAMA 90°	
Uzunluk:	160 mm
Pens Çapı:	6 mm
Taş Çapı:	38 mm
Boşta Devir:	20.000 Rpm
Hava Tüketimi:	178 lt/dk
Hava Giriş Nipeli:	1/4"
Hortum Çapı:	9.50 mm
Ağırlık:	0.14 kg
Koli Adedi:	12 adet

### OPT-P 129 KALIPÇI TAŞLAMA



KALIPÇI TAŞLAMA	
Uzunluk:	155 mm
Pens Çapı:	6 mm
Taş Çapı:	38 mm
Boşta Devir:	25.000 Rpm
Hava Tüketimi:	225 lt/dk
Hava Giriş Nipeli:	1/4"
Hortum Çapı:	9.50 mm
Ağırlık:	0.20 kg
Koli Adedi:	20 adet

### OPT-P 120 KALIPÇI TAŞLAMA



KALIPÇI TAŞLAMA	
Uzunluk:	155 mm
Pens Çapı:	6 mm
Taş Çapı:	38 mm
Boşta Devir:	25.000 Rpm
Hava Tüketimi:	178 lt/dk
Hava Giriş Nipeli:	1/4"
Hortum Çapı:	9.50 mm
Ağırlık:	0.14 kg
Koli Adedi:	12 adet

### OPT-P 106-2 LASTİK TEMİZLEME



LASTİK TEMİZLEME	
Uzunluk:	190 mm
Pens Çapı:	6 mm
Taş Çapı:	42 mm
Boşta Devir:	4.000 Rpm
Hava Tüketimi:	120 lt/dk
Hava Giriş Nipeli:	1/4"
Hortum Çapı:	9.50 mm
Çalışma Basıncı:	90 psi (6.2 atü)
Ağırlık:	0.82 kg
Koli Adedi:	10 adet
Koli Adedi:	50 adet

### OPT-P 515 KALIPÇI TAŞLAMA



KALIPÇI TAŞLAMA	
Uzunluk:	200 mm
Pens Çapı:	6 mm
Taş Çapı:	38 mm
Boşta Devir:	22.000 Rpm
Hava Tüketimi:	225 lt/dk
Hava Giriş Nipeli:	1/4"
Hortum Çapı:	9.50 mm
Çalışma Basıncı:	90 psi (6.2 atü)
Ağırlık:	0.56 kg
Koli Adedi:	20 adet

### OPT 127 KALIPÇI TAŞLAMA



KALIPÇI TAŞLAMA	
Uzunluk:	170 mm
Pens Çapı:	6 mm
Taş Çapı:	38 mm
Boşta Devir:	22.000 Rpm
Hava Tüketimi:	185 lt/dk
Hava Giriş Nipeli:	1/4"
Hortum Çapı:	9.50 mm
Çalışma Basıncı:	90 psi (6.2 atü)
Ağırlık:	0.74 kg
Koli Adedi:	20 adet

### OPT 121 KALIPÇI TAŞLAMA



KALIPÇI TAŞLAMA	
Uzunluk:	135 mm
Pens Çapı:	6 mm
Taş Çapı:	135 mm
Boşta Devir:	22.000 Rpm
Hava Tüketimi:	165 lt/dk
Hava Giriş Nipeli:	1/4"
Hortum Çapı:	9.50 mm
Çalışma Basıncı:	90 psi (6.2 atü)
Ağırlık:	0.35 kg
Koli Adedi:	20 adet

### OPT 4 KALIPÇI TAŞLAMA SET



KALIPÇI TAŞLAMA SET	
1 Adet OPT 127	
1 adet 1/8" Pens	
1 adet 1/4" Pens	
10 adet Saplı Taş ve Zımpara	
1 adet Plastik Çanta	
Koli Adedi 20 adet	



### OPC 62050 KALIPÇI TAŞLAMA



KALIPÇI TAŞLAMA	
Uzunluk:	230 mm
Pens Çapı:	6 mm
Taş Çapı:	30 mm
Güç:	0.368 kW
Boşta Devir:	21.000 Rpm
Hava Tüketimi:	120 lt/dk
Hava Giriş Nipeli:	1/4"
Hortum Çapı:	10.00 mm
Çalışma Basıncı:	90 psi (6.2 atü)
Ağırlık:	0.8 kg
Koli Adedi:	30 adet

### OPC 62075 KALIPÇI TAŞLAMA



KALIPÇI TAŞLAMA	
Uzunluk:	350 mm
Pens Çapı:	6 mm
Taş Çapı:	40 mm
Güç:	0.368 kW
Boşta Devir:	18.000 Rpm
Hava Tüketimi:	198 lt/dk
Hava Giriş Nipeli:	1/4"
Hortum Çapı:	10.00 mm
Çalışma Basıncı:	90 psi (6.2 atü)
Ağırlık:	1.6 kg
Koli Adedi:	30 adet

### OPC 68150 150 MM BORU TAŞLAMA



BORU TAŞLAMA	
Uzunluk:	540 mm
Taş Çapı:	150 mm
Boşta Devir:	6.600 Rpm
Hava Tüketimi:	930 lt/dk
Hava Giriş Nipeli:	3/8"
Hortum Çapı:	16.00 mm
Çalışma Basıncı:	90 psi (6.2 atü)
Ağırlık:	5.6 kg
Koli Adedi:	1 adet

### OPT-P 100L 100 MM BORU TAŞLAMA



BORU TAŞLAMA	
Uzunluk:	414 mm
Taş Çapı:	100x19x12,7
Boşta Devir:	9.500 Rpm
Hava Tüketimi:	800 lt/dk
Hava Giriş Nipeli:	3/8"
Hortum Çapı:	13.00 mm
Çalışma Basıncı:	90 psi (6.2 atü)
Ağırlık:	2.3 kg
Koli Adedi:	10 adet

### OPT-P 122S4 KALIPÇI TAŞLAMA



KALIPÇI TAŞLAMA	
Uzunluk:	306 mm
Pens Çapı:	6 mm
Taş Çapı:	25 mm
Güç:	0,35 kW
Boşta Devir:	24.000 Rpm
Hava Tüketimi:	400 lt/dk
Hava Giriş:	1/4"
Hortum Çapı:	10.00 mm
Çalışma Basıncı:	90 psi (6.2 atü)
Ağırlık:	0,90 kg
Koli Adedi:	10 adet

### OPT-P 122S5 KALIPÇI TAŞLAMA



KALIPÇI TAŞLAMA	
Uzunluk:	319 mm
Pens Çapı:	6 mm
Taş Çapı:	38 mm
Boşta Devir:	22.000 Rpm
Hava Tüketimi:	120 lt/dk
Hava Giriş Nipeli:	1/4"
Hortum Çapı:	9.50 mm
Çalışma Basıncı:	90 psi (6.2 atü)
Ağırlık:	1.05 kg
Koli Adedi:	20 adet

### OPT-P 501 MİKRO KALIPÇI TAŞLAMA



MİKRO KALIPÇI TAŞLAMA	
Uzunluk:	155 mm
Pens Çapı:	3 mm
Taş Çapı:	18.00 mm
Boşta Devir:	60.000 Rpm
Hava Tüketimi:	120 lt/dk
Hava Giriş Nipeli:	1/4"
Hortum Çapı:	6.50 mm
Çalışma Basıncı:	90 psi (6.2 atü)
Ağırlık:	0.30 kg
Koli Adedi:	20 adet

### OPT-P 1503 MİKRO KALIPÇI TAŞLAMA



MİKRO KALIPÇI TAŞLAMA	
Uzunluk:	160 mm
Pens Çapı:	3 mm
Taş Çapı:	18 mm
Boşta Devir:	60.000 Rpm
Hava Tüketimi:	200 Lt/Dk
Hava Giriş Nipeli:	1/4"
Hortum Çapı:	8.00 mm
Çalışma Basıncı:	90 psi (6.2 atü)
Ağırlık:	0.110 kg
Koli Adedi:	10 ad

### OPT-P 122S6 KALIPÇI TAŞLAMA



KALIPÇI TAŞLAMA	
Uzunluk:	367 mm
Pens Çapı:	6 mm
Taş Çapı:	45 mm
Boşta Devir:	14.600 Rpm
Güç:	0,50 kW
Hava Tüketimi:	600 lt/dk
Hava Giriş:	3/8"
Hortum Çapı:	10.00 mm
Çalışma Basıncı:	90 psi (6.2 atü)
Ağırlık:	1.5 kg

### OPT-P 122S8 UZUN TİP BORU TAŞLAMA



UZUN TİP BORU TAŞLAMA	
Uzunluk:	1050 mm
Taş Çapı:	100x19x12.7
Boşta Devir:	9.000 Rpm
Hava Tüketimi:	900 lt/dk
Hava Giriş Nipeli:	3/8"
Hortum Çapı:	13.00 mm
Çalışma Basıncı:	90 psi (6.2 atü)
Ağırlık:	5.4 kg
Koli Adedi:	1 adet

### OPT-P 513 PİPO KALIPÇI TAŞLAMA



KALIPÇI TAŞLAMA	
Uzunluk:	155 mm
Taş Çapı:	18 mm
Boşta Devir:	23.000 Rpm
Hava Tüketimi:	120 lt/dk
Hava Giriş Nipeli:	1/4"
Hortum Çapı:	6.50 mm
Çalışma Basıncı:	90 psi (6.2 atü)
Ağırlık:	0.30 kg
Koli Adedi:	10 adet



### OPT-P 1504 MİKRO KALIPÇI TAŞLAMA



MİKRO KALIPÇI TAŞLAMA	
Uzunluk:	180 mm
Pens Çapı:	3-6 mm
Taş Çapı:	20 mm
Boşta Devir:	35.000 Rpm
Hava Tüketimi:	200 lt/dk
Hava Giriş Nipeli:	1/4"
Hortum Çapı:	8.00 mm
Çalışma Basıncı:	90 psi (6,2 atü)
Ağırlık:	0.170 kg
Koli Adedi:	10 ad

### OPT-P 1505 MİKRO KALIPÇI TAŞLAMA



MİKRO KALIPÇI TAŞLAMA	
Uzunluk:	175 mm
Pens Çapı:	3 mm
Taş Çapı:	15 mm
Boşta Devir:	80.000 Rpm
Hava Tüketimi:	250 lt/dk
Hava Giriş Nipeli:	1/4"
Hortum Çapı:	8.00 mm
Çalışma Basıncı:	90 psi (6,2 atü)
Ağırlık:	0.40 kg
Koli Adedi:	10 ad

### OPC 60215 125 MM AVUÇ TAŞLAMA



125 MM AVUÇ TAŞLAMA	
Uzunluk:	264 mm
Taş Çapı:	125 mm
Ses Şiddeti:	83 dB(A)
Boşta Devir:	11.000 Rpm
Güç:	0.60 kW
Hava Tüketimi:	320 lt/dk
Hava Giriş Nipeli:	3/8"
Hortum Çapı:	13.00 mm
Çalışma Basıncı:	90-115 psi (6,2-8,0 atü)
Ağırlık:	1.9 kg
Koli Adedi:	9 adet

### OPT-P 6115 125 MM TAŞLAMA



125 MM TAŞLAMA	
Uzunluk:	264 mm
Taş Çapı:	125 mm
Boşta Devir:	11.000 Rpm
Güç:	0.60 kW
Hava Tüketimi:	630 lt/dk
Hava Giriş Nipeli:	3/8"
Hortum Çapı:	13.00 mm
Çalışma Basıncı:	90-115 psi (6,2-8,0 atü)
Ağırlık:	2.2 kg
Koli Adedi:	10 adet

### OPT-P 7301 EĞE MOTORU



EĞE MOTORU SAĞ SOL	
Uzunluk:	205 mm
Stroke:	0,3 mm
Stroke Sayısı:	15.000 spm
Hava Tüketimi:	170 lt/dk
Hava Giriş Nipeli:	1/4"
Hortum Çapı:	8.00 mm
Çalışma Basıncı:	90 psi (6,2 atü)
Ağırlık:	0.305 kg
Koli Adedi:	10 adet

### OPT-P 7203 EĞE MOTORU



EĞE MOTORU İLERİ GERİ	
Uzunluk:	200 mm
Stroke:	0,2 mm
Stroke Sayısı:	35.000 spm
Hava Tüketimi:	170 lt/dk
Hava Giriş Nipeli:	1/4"
Hortum Çapı:	8.00 mm
Çalışma Basıncı:	90 psi (6,2 atü)
Ağırlık:	0.190 kg
Koli Adedi:	10 adet

### OPT-P 6315 125 MM TAŞLAMA



125 MM TAŞLAMA	
Uzunluk:	262 mm
Taş Çapı:	125 mm
Boşta Devir:	12.000 Rpm
Güç:	960 kW / 1.3 hp
Hava Tüketimi:	900 lt/dk
Hava Giriş Nipeli:	3/8"
Hortum Çapı:	10.00 mm
Çalışma Basıncı:	6,3-8 atü
Ağırlık:	1.9 kg
Koli Adedi:	10 adet

### OPT 505 KABZALI TAŞLAMA



KABZALI TAŞLAMA	
Uzunluk:	135 mm
Taş Çapı:	100 mm
Boşta Devir:	15.000 Rpm
Hava Tüketimi:	150 lt/dk
Hava Giriş Nipeli:	1/4"
Hortum Çapı:	9.50 mm
Çalışma Basıncı:	90-115 psi (6,2-8,0 atü)
Ağırlık:	1.1 kg
Koli Adedi:	10 adet

### OPT-P 7205 EĞE MOTORU



EĞE MOTORU İLERİ GERİ	
Uzunluk:	200 mm
Stroke:	0,3 mm
Stroke Sayısı:	30.000 spm
Hava Tüketimi:	170 lt/dk
Hava Giriş Nipeli:	1/4"
Hortum Çapı:	8.00 mm
Çalışma Basıncı:	90 psi (6,2 atü)
Ağırlık:	0.190 kg
Koli Adedi:	10 adet

### OPT-P 7212 EĞE MOTORU



EĞE MOTORU İLERİ GERİ	
Uzunluk:	200 mm
Stroke:	0,7 mm
Stroke Sayısı:	28.000 spm
Hava Tüketimi:	170 lt/dk
Hava Giriş Nipeli:	1/4"
Hortum Çapı:	8.00 mm
Çalışma Basıncı:	90 psi (6,2 atü)
Ağırlık:	0.190 kg
Koli Adedi:	10 adet

### OPT-P 125 50 MM TAŞLAMA



TAŞLAMA	
Uzunluk:	188 mm
Taş Çapı:	50 mm
Boşta Devir:	15.000 Rpm
Hava Tüketimi:	400 lt/dk
Hava Giriş:	1/4"
Hortum Çapı:	8.00 mm
Çalışma Basıncı:	90 psi (6,2 atü)
Ağırlık:	0,7 kg
Koli Adedi:	10 adet

### OPC 60225 C 75 MM TAŞLAMA / KESME



75 MM TAŞLAMA / KESME	
Uzunluk:	290 mm
Taş Çapı:	75 mm
Ses Şiddeti:	83 dB(A)
Boşta Devir:	16.000 Rpm
Hava Tüketimi:	350 lt/dk
Hava Giriş Nipeli:	1/4"
Hortum Çapı:	10.00 mm
Çalışma Basıncı:	90-115 psi (6,2-8,0 atü)
Ağırlık:	1.3 kg
Koli Adedi:	10 adet



### OPT-P 6180 180 MM TAŞLAMA



180 MM TAŞLAMA	
Uzunluk:	392 mm
Taş Çapı:	180 mm
Boşta Devir:	7.500 Rpm
Güç:	1.00 kW
Hava Tüketimi:	800 lt/dk
Hava Giriş Nipeli:	3/8"
Hortum Çapı:	16.00 mm
Çalışma Basıncı:	90-115 psi (6.2-8.0 atü)
Ağırlık:	3.3 kg
Koli Adedi:	6 adet

### OPT-P 509 180 MM TAŞLAMA



180 MM TAŞLAMA	
Uzunluk:	343 mm
Taş Çapı:	180 mm
Boşta Devir:	7.000 Rpm
Güç:	1.1 kW
Hava Tüketimi:	340 lt/dk
Hava Giriş Nipeli:	3/8"
Hortum Çapı:	13.00 mm
Çalışma Basıncı:	90-115 psi (6.2-8.0 atü)
Ağırlık:	3.20 kg
Koli Adedi:	6 adet

### OPT-P 791 POLİSAJ



POLİSAJ	
Uzunluk:	343 mm
Taş Çapı:	180 mm
Boşta Devir:	2.500 Rpm
Hava Tüketimi:	340 lt/dk
Hava Giriş Nipeli:	1/2"
Hortum Çapı:	13.00 mm
Çalışma Basıncı:	90-115 psi (6.2-8.0 atü)
Ağırlık:	2.70 kg
Koli Adedi:	10 adet

### OPT-P 793 POLİSAJ



POLİSAJ	
Uzunluk:	343 mm
Taş Çapı:	180 mm
Boşta Devir:	3.000 Rpm
Hava Tüketimi:	220 lt/dk
Hava Giriş Nipeli:	3/8"
Hortum Çapı:	13.00 mm
Çalışma Basıncı:	90-115 psi (6.2-8.0 atü)
Ağırlık:	2.00 kg
Koli Adedi:	10 adet

### OPC 6218 180 MM TAŞLAMA



180 MM TAŞLAMA	
Uzunluk:	238.00 mm
Taş Çapı:	180 mm
Boşta Devir:	7.000 Rpm
Güç:	1.52 kW
Hava Tüketimi:	1.590 lt/dk
Hava Giriş Nipeli:	3/8"
Hortum Çapı:	16.00 mm
Çalışma Basıncı:	90-115 psi (6.2-8.0 atü)
Ağırlık:	3.40 kg
Koli Adedi:	4 adet

### OPC 60218 180 MM TAŞLAMA



180 MM TAŞLAMA	
Uzunluk:	323 mm
Taş Çapı:	180 mm
Boşta Devir:	7.500 Rpm
Güç:	1.65 kW
Hava Tüketimi:	1400 lt/dk
Hava Giriş Nipeli:	3/8"
Hortum Çapı:	16.00 mm
Çalışma Basıncı:	90-115 psi (6.2-8.0 atü)
Ağırlık:	3 kg
Koli Adedi:	6 adet

### OPT-P 799 POLİSAJ



POLİSAJ	
Uzunluk:	188.00 mm
Taban Çapı:	180 mm
Boşta Devir:	2.000 Rpm
Hava Tüketimi:	311 lt/dk
Hava Giriş Nipeli:	1/4"
Hortum Çapı:	10.00 mm
Çalışma Basıncı:	90-115 psi (6.2-8.0 atü)
Ağırlık:	2.20 kg
Koli Adedi:	10 adet

### OPT-P 6280-V 180MM TAŞLAMA



180 MM TAŞLAMA	
Uzunluk:	318 mm
Taş Çapı:	180 mm
Boşta Devir:	7.000 Rpm
Hava Tüketimi:	340 lt/dk
Hava Giriş Nipeli:	1/2"
Hortum Çapı:	13.00 mm
Hortum Çapı:	16.00 mm
Çalışma Basıncı:	90-115 psi (6.2-8.0 atü)
Ağırlık:	3.30 kg
Koli Adedi:	10 adet

### OPC 60230 230 MM TAŞLAMA



230 MM TAŞLAMA	
Uzunluk:	238.00 mm
Taş Çapı:	230 mm
Boşta Devir:	5.900 Rpm
Güç:	2.00 kW
Hava Tüketimi:	1.700 lt/dk
Hava Giriş Nipeli:	3/8"
Hortum Çapı:	19.00 mm
Çalışma Basıncı:	90-115 psi (6.2-8.0 atü)
Ağırlık:	3.80 kg
Koli Adedi:	4 adet



### OPC 62223D ORBİTAL 150 MM ZIMPARA



150 MM ZIMPARA	
Vibrasyon:	< 2.5 mm
Orbital Çapı:	5 mm
Taş Çapı:	125-150 mm
Boşta Devir:	0-10.000 Rpm
Hava Tüketimi:	151 lt/dk
Hava Giriş Nipeli:	1/4"
Hortum Çapı:	11.00 mm
Çalışma Basıncı:	90-115 psi (6.2-8.0 atü)
Ses Şiddeti:	85 dB(A)
Ağırlık:	1.30 kg
Koli Adedi:	10 adet

### OPC 62303B ORBİTAL 150 MM ZIMPARA



150 MM ZIMPARA	
Vibrasyon:	2.5 mm
Orbital Çapı:	5 mm
Taban Çapı:	125-150 mm
Boşta Devir:	0-12.000 Rpm
Hava Tüketimi:	151 lt/dk
Hava Giriş Nipeli:	1/4"
Hortum Çapı:	11.00 mm
Çalışma Basıncı:	90-115 psi (6.2-8.0 atü)
Ses Şiddeti:	76 dB(A)
Ağırlık:	0.78 kg
Koli Adedi:	6 adet

### OPT-P 701 BANT ZIMPARA



BANT ZIMPARA	
Uzunluk:	280 mm
Bant Ölçüsü:	10x330 mm
Boşta Devir:	19.000 Rpm
Hava Tüketimi:	226 lt/dk
Hava Giriş Nipeli:	1/4"
Hortum Çapı:	10.00 mm
Çalışma Basıncı:	90-115 psi (6.2-8.0 atü)
Ağırlık:	0.80 kg
Koli Adedi:	10 adet

### OPT-P 701C BANT ZIMPARA

YENİ



BANT ZIMPARA	
Uzunluk:	325 mm
Bant Ölçüsü:	10x330 mm
Boşta Devir:	18.000 Rpm
Hava Tüketimi:	270 lt/dk
Hava Giriş Nipeli:	1/4"
Hortum Çapı:	10.00 mm
Çalışma Basıncı:	90-115 psi (6.2-8.0 atü)
Ağırlık:	0.80 kg
Koli Adedi:	10 adet

### OPT-P 309B ORBİTAL ZIMPARA



ORBİTAL ZIMPARA VAKUMLU	
Vibrasyon:	< 2 mm
Orbital Çapı:	5 mm
Taş Çapı:	125-150 mm
Boşta Devir:	0-12.000 Rpm
Hava Tüketimi:	151 lt/dk
Hava Giriş Nipeli:	1/4"
Hortum Çapı:	11.00 mm
Çalışma Basıncı:	90-115 psi (6.2-8.0 atü)
Ağırlık:	0.78 kg
Koli Adedi:	6 adet

### OPT-P 309BW ORBİTAL ZIMPARA



ORBİTAL ZIMPARA VAKUMSUZ	
Vibrasyon:	< 2 mm
Orbital Çapı:	5 mm
Taban Çapı:	125-150 mm
Boşta Devir:	0-12.000 Rpm
Hava Tüketimi:	151 lt/dk
Hava Giriş Nipeli:	1/4"
Hortum Çapı:	11.00 mm
Çalışma Basıncı:	90-115 psi (6.2-8.0 atü)
Ağırlık:	0.60 kg
Koli Adedi:	10 adet

### OPT-P 702 BANT ZIMPARA



BANT ZIMPARA	
Uzunluk:	360 mm
Bant Ölçüsü:	20x520 mm
Boşta Devir:	18.000 Rpm
Hava Tüketimi:	255 lt/dk
Hava Giriş Nipeli:	1/4"
Hortum Çapı:	10.00 mm
Çalışma Basıncı:	90-115 psi (6.2-8.0 atü)
Ağırlık:	1.20 kg
Koli Adedi:	10 adet

### OPT 708 HAVALI RENDE



HAVALI RENDE	
Uzunluk:	410 mm
Taban Çapı:	63,6x400 mm
Boşta Devir:	3.000 Rpm
Hava Tüketimi:	250 lt/dk
Hava Giriş Nipeli:	1/4"
Hortum Çapı:	9.50 mm
Çalışma Basıncı:	90-115 psi (6.2-8.0 atü)
Ağırlık:	2.60 kg
Koli Adedi:	10 adet

### OPT 700-A ORBİTAL ZIMPARA



ORBİTAL ZIMPARA	
Vibrasyon:	< 2.5 mm
Orbital Çapı:	5 mm
Taban Çapı:	150 mm
Boşta Devir:	11.000 Rpm
Hava Tüketimi:	180 lt/dk
Hava Giriş Nipeli:	1/4"
Hortum Çapı:	10.00 mm
Çalışma Basıncı:	6.3-8 atü
Ağırlık:	0.90 kg
Koli Adedi:	6 adet

### OPC 62403 ORBİTAL ZIMPARA



ORBİTAL ZIMPARA VAKUMLU	
Vibrasyon:	< 2 mm
Orbital Çapı:	5 mm
Taş Çapı:	125-150 mm
Boşta Devir:	0-900 Rpm
Hava Tüketimi:	151 lt/dk
Hava Giriş Nipeli:	1/4"
Hortum Çapı:	10.00 mm
Çalışma Basıncı:	90-115 psi (6.2-8.0 atü)
Ağırlık:	0.9 kg
Koli Adedi:	6 adet

### OPC 65110-C TEL ZIMPARA



TEL ZIMPARA	
Uzunluk:	210 mm
Zımpara Çapı:	30x540 mm
Boşta Devir:	3.500 Rpm
Hava Tüketimi:	255 lt/dk
Hava Giriş Nipeli:	1/4"
Hortum Çapı:	10.00 mm
Çalışma Basıncı:	90-115 psi (6.2-8.0 atü)
Ses şiddeti:	80 dB(A)
Ağırlık:	1.20 kg
Ağırlık:	0.60 kg





### OPT-P 800A ORBİTAL ZIMPARA



75 mm ZIMPARA	
Vibrasyon:	< 2.5 mm
Taban Çapı:	75 mm
Orbital Çapı:	5 mm
Boşta Devir:	0-11.000 Rpm
Hava Tüketimi:	151 lt/dk
Hava Giriş Nipeli:	1/4"
Hortum Çapı:	11.00 mm
Çalışma Basıncı:	90-115 psi (6.2-8.0 atü)
Ağırlık:	0.65 kg
Koli Adedi:	10 adet

### OPT 500A TİTREŞİM ZIMPARA



TİTREŞİM ZIMPARA	
Vibrasyon:	< 2.5 mm
Taban Çapı:	100 mm
Orbital Çapı:	3.2 mm
Boşta Devir:	0-10.000 Rpm
Hava Tüketimi:	150 lt/dk
Hava Giriş Nipeli:	1/4"
Hortum Çapı:	10.00 mm
Çalışma Basıncı:	90-115 psi (6.2-8.0 atü)
Ağırlık:	0.70 kg
Koli Adedi:	10 adet

### OPT 313 TESTERE MOTORU



TESTERE MOTORU	
Uzunluk:	235 mm
Kesme Kapasitesi:	Çelik 1.20 mm Sac 1.60 mm Alüminyum 2.00 mm
Stroke:	10.0 mm
Stroke Sayısı:	9.500 d/dk
Hava Tüketimi:	113 lt/dk
Hava Giriş Nipeli:	1/4"
Hortum Çapı:	9.50 mm
Çalışma Basıncı:	90 psi (6.2 atü)
Ağırlık:	0.54 kg
Koli Adedi:	25 adet

### OPT-P 312 TESTERE MOTORU



TESTERE MOTORU	
Uzunluk:	262 mm
Kesme Kapasitesi:	Çelik 1.60 mm Sac 2.00 mm Alüminyum 3.26 mm
Stroke:	10.0 mm
Stroke Sayısı:	9.000 d/dk
Hava Tüketimi:	113 lt/dk
Hava Giriş Nipeli:	1/4"
Hortum Çapı:	9.50 mm
Çalışma Basıncı:	90 psi (6.2 atü)
Ağırlık:	0.70 kg
Koli Adedi:	20 adet

### OPT-P 368 DAİRE ZIMPARA



DAİRE ZIMPARA	
Uzunluk:	148 mm
Taban Çapı:	50 mm
Boşta Devir:	15.000 Rpm
Hava Tüketimi:	130 lt/dk
Hava Giriş Nipeli:	1/4"
Hortum Çapı:	9.50 mm
Çalışma Basıncı:	90 psi (6.2 atü)
Ağırlık:	0.70 kg
Koli Adedi:	10 adet

### OPT-P 716A DAİRE ZIMPARA



DAİRE ZIMPARA	
Uzunluk:	148 mm
Taban Çapı:	75 mm
Boşta Devir:	18.000 Rpm
Hava Tüketimi:	130 lt/dk
Hava Giriş Nipeli:	1/4"
Hortum Çapı:	9.50 mm
Çalışma Basıncı:	90 psi (6.2 atü)
Ağırlık:	0.60 kg
Koli Adedi:	10 adet

### OPT-P 319 TESTERE MOTORU



TESTERE MOTORU	
Uzunluk:	310 mm
Kesme Kapasitesi:	Çelik 1.60 mm Sac 2.00 mm Alüminyum 3.26 mm
Stroke:	10.0 mm
Stroke Sayısı:	9.500 d/dk
Hava Tüketimi:	170 lt/dk
Hava Giriş Nipeli:	1/4"
Hortum Çapı:	9.50 mm
Çalışma Basıncı:	90 psi (6.2 atü)
Ağırlık:	0.51 kg
Koli Adedi:	10 adet

### OPT 673 HAVALI TOKMAK



HAVALI TOKMAK	
Strok Sayısı:	1.000 d/dk
Çalışma Basıncı:	4-7 bar
Hava Giriş:	1. Apr
Ağırlık:	0,90 kg
Koli Adedi:	10 Adet

### OPT 706 TİTREŞİM ZIMPARA



TİTREŞİM ZIMPARA	
Uzunluk:	170 mm
Taban Çapı:	93x165 mm
Boşta Devir:	0-8.000 Rpm
Hava Tüketimi:	90 lt/dk
Hava Giriş Nipeli:	1/4"
Hortum Çapı:	9.50 mm
Çalışma Basıncı:	90-115 psi (6.2-8.0 atü)
Ağırlık:	2.30 kg
Koli Adedi:	10 adet

### OPT-P 363 TİTREŞİM ZIMPARA



TİTREŞİM ZIMPARA	
Uzunluk:	230 mm
Taban Çapı:	110x220 mm
Boşta Devir:	0-6.000 Rpm
Hava Tüketimi:	155 lt/dk
Hava Giriş Nipeli:	1/4"
Hortum Çapı:	11.00 mm
Çalışma Basıncı:	90-115 psi (6.2-8.0 atü)
Ağırlık:	2.20 kg
Koli Adedi:	6 adet

### OPT-P 618 PUNTA ÇÜRÜTME



PUNTA ÇÜRÜTME	
Uzunluk:	210 mm
Freze Çapı:	8.0 mm
Boşta Devir:	500 Rpm
Hava Tüketimi:	235 lt/dk
Hava Giriş Nipeli:	1/4"
Hortum Çapı:	9.50 mm
Çalışma Basıncı:	90 psi (6.2 atü)
Ağırlık:	1.60 kg
Koli Adedi:	10 adet



### OPT 103R POP PERÇİN



POP PERÇİN	
Yükseklik:	290 mm
Perçin Çapı:	2.4-3.2-4-4.8 mm Alüminyum
Çekme Kapasitesi:	730 kg
Hortum Çapı:	6.50 mm
Hava Tüketimi:	40 lt/dk
Çalışma Basıncı:	90-115 psi (6.2-8.0 atü)
Ağırlık:	1.50 kg
Koli Adedi:	10 adet

### OPT 103K POP PERÇİN



POP PERÇİN	
Opt 103 R:	1 adet
Tamir Takımı:	1 set
Plastik Çanta:	1 adet
Koli Adedi:	8 adet

### OPT-P 5012 POP PERÇİN



POP PERÇİN	
Yükseklik:	273 mm
Perçin Çapı:	2.4-5 mm Alüminyum 2.4-4 mm Çelik
Çekme Kapasitesi:	870 kg
Strok:	14 mm
Hava Tüketimi:	60 lt/dk
Hava Giriş Nipeli:	1/4"
Hortum Çapı:	8.00 mm
Çalışma Basıncı:	90-115 psi (6.2-7.0 atü)
Ağırlık:	1.40 kg
Koli Adedi:	1 adet

### OPT-P 5020 POP PERÇİN



POP PERÇİN	
Yükseklik:	281 mm
Perçin Çapı:	2.4-5 mm Alüminyum 2.4-5 mm Çelik
Çekme Kapasitesi:	1.800 kg
Strok:	16 mm
Hava Tüketimi:	80 lt/dk
Hava Giriş Nipeli:	1/4"
Hortum Çapı:	8.00 mm
Çalışma Basıncı:	90-115 psi (6.2-7.0 atü)
Ağırlık:	1.60 kg
Koli Adedi:	1 adet

### OPT-P 4000R POP PERÇİN



POP PERÇİN	
Yükseklik:	288 mm
Perçin Çapı:	3.2-4-4.8 mm Çelik
Çekme Kapasitesi:	1.100 kg
Hava Tüketimi:	40 lt/dk
Hava Giriş Nipeli:	1/4"
Hortum Çapı:	8.00 mm
Hortum Çapı:	9.50 mm
Çalışma Basıncı:	90-115 psi (6.2-8.0 atü)
Ağırlık:	1.30 kg
Koli Adedi:	6 adet

### OPT-P 101 POP PERÇİN



POP PERÇİN	
Yükseklik:	190 mm
Perçin Çapı:	2.4-3.2-4-4.8 mm Çelik
Çekme Kapasitesi:	900 kg
Hava Tüketimi:	80 lt/dk
Hava Giriş Nipeli:	1/4"
Hortum Çapı:	8.00 mm
Hortum Çapı:	9.50 mm
Çalışma Basıncı:	90-115 psi (6.2-8.0 atü)
Ağırlık:	1.50 kg
Koli Adedi:	10 adet

### OPT-P 5040N POP PERÇİN



POP PERÇİN	
Yükseklik:	281 mm
Perçin Çapı:	4-4.8-6-6.4 mm Çelik
Strok:	14 mm
Çekme Kapasitesi:	2.100 kg
Hava Tüketimi:	80 lt/dk
Hava Giriş Nipeli:	1/4"
Hortum Çapı:	8.00 mm
Çalışma Basıncı:	90-115 psi (6.2-7.0 atü)
Ağırlık:	2.00 kg
Standart Aksesuar:	4-5-6-6.4 Pens
Koli Adedi:	1 adet

### OPT-P 5060N POP PERÇİN



MONOBOLT PERÇİN	
Yükseklik:	340 mm
Perçin Çapı:	8 mm Alüminyum 4-4.8-6-6.4 Çelik
Strok:	26 mm
Çekme Kapasitesi:	1.820 kg
Hava Tüketimi:	90 lt/dk
Hava Giriş Nipeli:	1/4"
Hortum Çapı:	8.00 mm
Çalışma Basıncı:	90-115 psi (6.2-7.0 atü)
Ağırlık:	2.60 kg
Standart Aksesuar:	4-5-6-6.4 Pens
Koli Adedi:	1 adet

### OPT-PS 6 SOMUNLU PERÇİN



SOMUNLU PERÇİN	
Yükseklik:	288 mm
Perçin Çapı:	3-4-5-6
Çekme Kapasitesi:	1.100 kg
Hava Tüketimi:	240 lt/dk
Hava Giriş Nipeli:	1/4"
Hortum Çapı:	8.00 mm
Çalışma Basıncı:	90-115 psi (6.2-8.0 atü)
Ağırlık:	1.30 kg
Koli Adedi:	6 adet

### OSA-PS 6 YEDEK UÇ



Yedek Uç:	
	3-4-5-6 mm

### OPT-P 5075 LOCKBOLT POP PERÇİN



POP PERÇİN	
Yükseklik:	319 mm
Perçin Çapı SRB:	5-6.5 mm
BOM:	5 mm
Hucktainer:	10 mm
Strok:	15 mm
Çekme Kapasitesi:	2.200 kg
Hava Tüketimi:	100 lt/dk
Hava Giriş Nipeli:	1/4"
Hortum Çapı:	8.00 mm
Çalışma Basıncı:	90-115 psi (6.2-7.0 atü)
Ağırlık:	2.20 kg
Koli Adedi:	1 adet





### OPT-P 5050 AS SOMUNLU PERÇİN



SOMUNLU PERÇİN	
Yükseklik:	292 mm
Perçin Çapı:	3-12 mm Çelik
Çekme Kapasitesi:	2.400 kg
Hava Tüketimi:	90 lt/dk
Hava Giriş Nipeli:	1/4"
Hortum Çapı:	8.00 mm
Çalışma Basıncı:	90-115 psi (6.2-7.0 atü)
Ağırlık:	2.20 kg
Standart Aksesuar:	4-5-6-8-10 mm Bağlantı Çubuğu
Koli Adedi:	1 adet
Kafadan strok ayarlı, M3-M5 arası standart imbus vida kullanımı	

### OPT-P 5050 SOMUNLU PERÇİN



SOMUNLU PERÇİN	
Yükseklik:	292 mm
Perçin Çapı:	3-12 mm
Çekme Kapasitesi:	2.400 kg
Hortum Çapı:	8.00 mm
Hava Giriş Nipeli:	1/4"
Hava Tüketimi:	90 lt/dk
Çalışma Basıncı:	90-115 psi (6.2-7.0 atü)
Ağırlık:	2.20 kg
Standart Aksesuar:	4-5-6-8-10 mm Bağlantı Çubuğu
Koli Adedi:	1 adet

### OPT-P 50100 SOMUNLU PERÇİN



SOMUNLU PERÇİN	
Yükseklik:	306 mm
Perçin Çapı:	6-16 mm Çelik
Çekme Kapasitesi:	3.400 kg
Hava Tüketimi:	90 lt/dk
Hava Giriş Nipeli:	1/4"
Hortum Çapı:	8.00 mm
Çalışma Basıncı:	90-115 psi (6.2-7.0 atü)
Ağırlık:	2.90 kg
Standart Aksesuar:	8-10-12-14 mm Bağlantı Çubuğu
Koli Adedi:	1 adet

### OPT-P 5170R ŞARJLI POP PERÇİN



POP PERÇİN	
Perçin Çapı:	2,4-4,8 mm Çelik
Strok:	20mm
Çekme Kapasitesi:	850 kg
Batarya:	14,4 V/Li-ion
Şarj Süresi:	60 dakika
Ağırlık:	2.10 kg
Hortum Çapı:	8.00 mm
Standart Aksesuarlar:	1 adet 14.4 V Akü Şarj Ünitesi
Koli Adedi:	6 adet

### OPT-P 5050 VE OPT-P 5050AS IMBUS CİVATA ADAPTORÜ

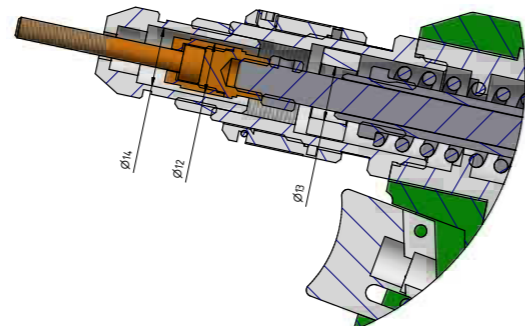
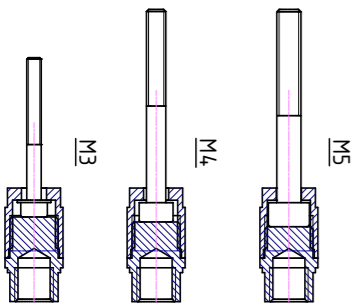



### OPT 150-6K KALAFAT ÇEKİCİ



KALAFAT ÇEKİCİ	
Uzunluk:	150 mm
Piston Çapı:	18.00 mm
Stroke:	43 mm
Boşta Darbe:	4.600 d/dk
Hava Tüketimi:	150 lt/dk
Hava Giriş Nipeli:	1/4"
Hortum Çapı:	9.50 mm
Çalışma Basıncı:	90-115 psi (6.2-8.0 atü)
Darbe Enerji Değeri:	3,9 joule
Ağırlık:	1.30 kg
Koli Adedi:	10 adet

### OPT 190-4K KALAFAT ÇEKİCİ



KALAFAT ÇEKİCİ	
Uzunluk:	190 mm
Piston Çapı:	21 mm
Stroke:	66 mm
Boşta Darbe:	3.000 d/dk
Hava Tüketimi:	190 lt/dk
Hava Giriş Nipeli:	1/4"
Hortum Çapı:	9.50 mm
Çalışma Basıncı:	90-115 psi (6.2-8.0 atü)
Darbe Enerji Değeri:	8,7 joule
Ağırlık:	2.30 kg
Koli Adedi:	6 adet

### OPT 281 ÇİVİLİ RASPA



ÇİVİLİ RASPA	
Uzunluk:	355 mm
Piston Çapı:	20 mm
Stroke:	43 mm
Boşta Darbe:	4.500 d/dk
İğne Çapı:	3x180 mm
Hava Tüketimi:	250 lt/dk
Hava Giriş Nipeli:	1/4"
Hortum Çapı:	10.00 mm
Çalışma Basıncı:	90-115 psi (6.2-8.0 atü)
Ağırlık:	2.20 kg
Koli Adedi:	10 adet

### OPT-P 110 ÇİVİLİ RASPA



ÇİVİLİ RASPA	
Uzunluk:	252 mm
Piston Çapı:	20 mm
Stroke:	16 mm
Boşta Darbe:	3.000 d/dk
İğne Çapı:	3x180 mm
Hava Tüketimi:	283 lt/dk
Hava Giriş Nipeli:	1/4"
Hortum Çapı:	9.50 mm
Çalışma Basıncı:	90-115 psi (6.2-8.0 atü)
Ağırlık:	2.60 kg
Koli Adedi:	6 adet

### OPT-P 180-4 K KALAFAT ÇEKİCİ



KALAFAT ÇEKİCİ	
Uzunluk:	190 mm
Piston Çapı:	23 mm
Stroke:	66 mm
Boşta Darbe:	3.200 d/dk
Hava Tüketimi:	210 lt/dk
Hava Giriş Nipeli:	1/4"
Hortum Çapı:	10.00 mm
Çalışma Basıncı:	90-115 psi (6.2-8.0 atü)
Darbe Enerji Değeri:	8,7 joule
Ağırlık:	2.60 kg
Koli Adedi:	6 adet

### OPT-P 11 KALAFAT ÇEKİCİ



KALAFAT ÇEKİCİ	
Uzunluk:	245 mm
Perçin Çapı:	6 mm
Stroke:	45 mm
Boşta Darbe:	3.000 d/dk
Hava Tüketimi:	550 lt/dk
Hava Giriş Nipeli:	1/4"
Hortum Çapı:	11.00 mm
Çalışma Basıncı:	90-115 psi (6.2-8.0 atü)
Darbe Enerji Değeri:	6,6 joule
Ağırlık:	2.50 kg
Koli Adedi:	2 adet

### OPT-P 10 KALAFAT ÇEKİCİ



KALAFAT ÇEKİCİ	
Uzunluk:	175 mm
Piston Çapı:	19 mm
Stroke:	16 mm
Boşta Darbe:	4.000 d/dk
İğne Çapı:	3x125 mm
Hava Tüketimi:	170 lt/dk
Hava Giriş Nipeli:	1/4"
Hortum Çapı:	9.50 mm
Çalışma Basıncı:	90-115 psi (6.2-8.0 atü)
Ağırlık:	1.20 kg
Koli Adedi:	10 adet

### OPT-P 20 KALAFAT ÇEKİCİ



KALAFAT ÇEKİCİ	
Uzunluk:	410 mm
Piston Çapı:	25 mm
Stroke:	22 mm
Boşta Darbe:	4.000 d/dk
İğne Çapı:	3x180 mm
Hava Tüketimi:	300 lt/dk
Hava Giriş Nipeli:	1/4"
Hortum Çapı:	11.00 mm
Çalışma Basıncı:	90-115 psi (6.2-8.0 atü)
Ağırlık:	2.30 kg
Koli Adedi:	10 adet

### OPT-P 12 KALAFAT ÇEKİCİ



KALAFAT ÇEKİCİ	
Uzunluk:	380 mm
Perçin Çapı:	7.5 mm
Stroke:	51 mm
Boşta Darbe:	2.500 d/dk
Hava Tüketimi:	600 lt/dk
Hava Giriş Nipeli:	3/8"
Hortum Çapı:	13.00 mm
Çalışma Basıncı:	90-115 psi (6.2-8.0 atü)
Darbe Enerji Değeri:	22,90 joule
Ağırlık:	6.50 kg
Koli Adedi:	2 adet

### OPT-P 15 KALAFAT ÇEKİCİ



KALAFAT ÇEKİCİ	
Uzunluk:	425 mm
Perçin Çapı:	13 mm
Stroke:	102 mm
Boşta Darbe:	1.500 d/dk
Hava Tüketimi:	600 lt/dk
Hava Giriş Nipeli:	3/8"
Hortum Çapı:	13.00 mm
Çalışma Basıncı:	90-115 psi (6.2-8.0 atü)
Darbe Enerji Değeri:	30,46 joule
Ağırlık:	9.00 kg
Koli Adedi:	2 adet

### OPT-P 710-LK ÇİVİLİ RASPA



ÇİVİLİ RASPA	
Uzunluk:	710 mm
Piston Çapı:	16 mm
Stroke:	16 mm
Boşta Darbe:	4.600 d/dk
İğne Çapı:	3x125 mm
Hava Tüketimi:	85 lt/dk
Hava Giriş Nipeli:	1/4"
Hortum Çapı:	9.50 mm
Çalışma Basıncı:	90-115 psi (6.2-8.0 atü)
Ağırlık:	2.60 kg
Koli Adedi:	6 adet

### OPT 923 RASPA ÇEKİCİ



RASPA ÇEKİCİ	
Uzunluk:	480 mm
Keski Çapı:	15 mm
Boşta Darbe:	7.200 d/dk
Hava Tüketimi:	85 lt/dk
Hava Giriş Nipeli:	1/4"
Hortum Çapı:	9.50 mm
Çalışma Basıncı:	90-115 psi (6.2-8.0 atü)
Ağırlık:	1.50 kg
Koli Adedi:	6 adet



## OPT 203 SİLİKON TABANCASI



SİLİKON TABANCASI	
Uzunluk:	310 mm
Hava Giriş Nipeli:	1/4"
Çalışma Basıncı:	90 psi (6.2 atü)
Ağırlık:	0.40 kg
Koli Adedi:	10 adet

## OPT 2032-13 SOSİS TABANCASI



SOSİS TABANCASI	
Tüp Ölçüsü:	50x325 ml
Hava Giriş Nipeli:	1/4"
Hava Basıncı:	4-6 atü
Sosiste:	400-500-600 ml
Koli Adedi:	10 adet

## OPT-P 220 MİKSER



MİKSER	
Uzunluk:	910 mm
Karıştırma Kapasitesi:	20 lt
Piston:	3 adet
Boşta Devir:	3600 Rpm
Hava Tüketimi:	260 lt/dk
Hava Giriş Nipeli:	3/8"
Hortum Çapı:	11 mm
Çalışma Basıncı:	90-115 psi (6.2-8.0 atü)
Ağırlık:	5.50 kg
Koli Adedi:	1 adet

## OPT-P 221 MİKSER / VARİL TİP



MİKSER	
Uzunluk:	1110 mm
Karıştırma Kapasitesi:	30 lt
Piston:	3 adet
Boşta Devir:	630 Rpm
Hava Tüketimi:	260 lt/dk
Hava Giriş Nipeli:	3/8"
Hortum Çapı:	11 mm
Çalışma Basıncı:	(6.2-8.0 atü)
Ağırlık:	10 kg
Koli Adedi:	1 adet

## OPT-P 2033-13 SOSİS TABANCASI



SOSİS TABANCASI	
Tüp Ölçüsü:	50x325 ml
Hava Giriş Nipeli:	1/4"
Hava Basıncı:	4-6 atü
Sosiste:	400-500-600 ml
Koli Adedi:	10 adet

## OPT-P 2034-13 SOSİS TABANCASI İPLİ



SOSİS TABANCASI	
Tüp Ölçüsü:	50x325 ml
Hava Giriş Nipeli:	1/4"
Hava Basıncı:	4-6 atü
Sosiste:	400-500-600 ml
Koli Adedi:	10 adet

## OPT-P QS-2 KAPORTA ÇEKTİRME



KAPORTA ÇEKTİRME	
Kayar Çekiç:	1.36 kg
Emme tamponu:	2 adet
Saptan hava boşaltma	
Hava tamponu:	1/4"
Koli Adedi:	4 adet

## OPT 201 VAKUMLU SÜPÜRGE



VAKUM	
Hava Giriş Nipeli:	1/4"
Koli Adedi:	20 adet

## OPT 206 GRES POMPASI



GRES POMPASI	
Hava Tüketimi:	60 lt
Hava Giriş Nipeli:	1/4"
Hortum Çapı:	6 mm
Çalışma Basıncı:	6.3-8 atü
Ağırlık:	0.45 kg
Koli Adedi:	10 adet



### OPT 3042 FR-L ŞARTLANDIRICI 1/2"



ŞARTLANDIRICI	
Hava Girişi:	1/2"
Filtre:	20µ
Çalışma Basıncı:	0.5-9.9 atü
Çalışma Sıcaklığı:	5-60°C
Su Kapasitesi:	80 ml
Hava Geçirgenliği:	2200 lt/dk
Koli Adedi:	12 adet

### OPT 2042 FR SU TUTUCU 1/2"



SU TUTUCU	
Hava Girişi:	1/2"
Filtre:	20µ
Çalışma Basıncı:	0.5-9.9 atü
Çalışma Sıcaklığı:	5-60°C
Su Kapasitesi:	80 ml
Hava Geçirgenliği:	2.200 lt/dk
Koli Adedi:	12 adet

### OPT-P 1000 SU TUTUCU



SU TUTUCU	
Uzunluk:	155 mm
Çalışma Basıncı:	1-70 kg/cm <sup>2</sup>
Max. Çalışma Akış Hızı:	300 lt/dk
Max. Basıncı:	14 bar
Akışkan Sıcaklığı:	5-60°C
Giriş Bağlantısı:	1/4"
Çıkış Bağlantısı:	1/4"
Nem Ayırma:	96%
Ağırlık:	0.60 kg
Koli Adedi:	20 adet

### OPT-P 2000 SU TUTUCU



SU TUTUCU	
Uzunluk:	215 mm
Çalışma Basıncı:	1-70 kg/cm <sup>2</sup>
Max. Çalışma Akış Hızı:	400 lt/dk
Max. Basıncı:	14 bar
Akışkan Sıcaklığı:	5-60°C
Giriş Bağlantısı:	1/2"
Çıkış Bağlantısı:	1/2"
Nem Ayırma:	96%
Ağırlık:	0.70 kg
Koli Adedi:	20 adet

### OPT 3012 FR-L ŞARTLANDIRICI 1/4"



ŞARTLANDIRICI	
Hava Girişi:	1/4"
Filtre:	20µ
Çalışma Basıncı:	0.5-9.9 atü
Çalışma Sıcaklığı:	5-60°C
Su Kapasitesi:	15 ml
Hava Geçirgenliği:	1.100 lt/dk
Koli Adedi:	28 adet

### OPT 2012 FR SU TUTUCU 1/4"



SU TUTUCU	
Hava Girişi:	1/4"
Filtre:	20µ
Çalışma Basıncı:	0.5-9.9 atü
Çalışma Sıcaklığı:	5-60°C
Su Kapasitesi:	15 ml
Hava Geçirgenliği:	1.100 lt/dk
Koli Adedi:	30 adet

### OPT-P 3000 SU TUTUCU



SU TUTUCU	
Uzunluk:	320 mm
Çalışma Basıncı:	1-70 kg/cm <sup>2</sup>
Max. Çalışma Akış Hızı:	800 lt/dk
Max. Basıncı:	14 bar
Akışkan Sıcaklığı:	5-60°C
Giriş Bağlantısı:	3/4"
Çıkış Bağlantısı:	3/4"
Nem Ayırma:	96%
Ağırlık:	2.30 kg
Koli Adedi:	6 adet

### OPT-P 2001 SU TUTUCU FİLTRE



SU TUTUCU	
Uzunluk:	320 mm
Çalışma Basıncı:	1-70 kg/cm <sup>2</sup>
Max. Çalışma Akış Hızı:	1200 lt/dk
Max. Basıncı:	8 bar
Akışkan Sıcaklığı:	5-60°C
Giriş Bağlantısı:	1/2"
Çıkış Bağlantısı:	1/2"
Ağırlık:	2.30 kg
Koli Adedi:	6 adet

### OPT 4042 FR-L 1" ŞARTLANDIRICI



ŞARTLANDIRICI	
Hava Girişi:	1"
Filtre:	20µ
Çalışma Basıncı:	1-12 atü
Çalışma Sıcaklığı:	5-60°C
Su kapasitesi:	150 ml
Hava geçirgenliği:	3.500 lt/dk
Koli Adedi:	4 adet

### OPT-P 3001 SU TUTUCU FİLTRE



SU TUTUCU	
Uzunluk:	360 mm
Çalışma Basıncı:	1-70 kg/cm <sup>2</sup>
Max. Çalışma Akış Hızı:	2200 lt/dk
Max. Basıncı:	8 bar
Akışkan Sıcaklığı:	5-60°C
Giriş Bağlantısı:	3/4"
Çıkış Bağlantısı:	3/4"
Ağırlık:	3.00 kg
Koli Adedi:	6 adet





**OSAKA**<sup>®</sup> [www.osaka.com.tr](http://www.osaka.com.tr)

Hortumlar



## SPİRAL HAVA HORTUMLARI POLİÜRETAN



Kod	İç x Dış Çap	Uzunluk	Koli Adeti	Fiyat
OPT05-25	5.0x8.0 mm	7.5 m	50	
OPT05-50	5.0x8.0 mm	15 m	30	
OPT06-25	6.5x10.0 mm	7.5 m	40	
OPT06-50	6.5x10.0 mm	15 m	20	
OPT08-25	8.0x12.0 mm	7.5 m	40	
OPT08-50	8.0x12.0 mm	15 m	20	
OPT11-25	11.0x16.0 mm	7.5 m	20	
OPT11-50	11.0x16.0 mm	15 m	10	

## OKSİJEN ASETİLEN HORTUMU



ÇALIŞMA BASINCI 20 bar / PATLAMA BASINCI 60 bar			Fiyat
OSA-H 0816	8 mm Oksijen Hortumu	100 m	
OSA-H 1020	10 mm Oksijen Hortumu	100 m	
OSA-H 2816	Çiftli Hortum	50 m	

## POLİÜRETAN RULO HORTUMLAR



2.5x4	PU Hava Hortumu	200 m	Şeffaf-Mavi-Turuncu	
3x5	PU Hava Hortumu	200 m	Şeffaf-Mavi-Turuncu	
4x6	PU Hava Hortumu	200 m	Şeffaf-Mavi-Turuncu	
5x8	PU Hava Hortumu	100 m	Şeffaf-Mavi-Turuncu	
6.5x10	PU Hava Hortumu	100 m	Mavi-Turuncu	
8x12	PU Hava Hortumu	100 m	Mavi-Turuncu	
11x16	PU Hava Hortumu	100 m	Mavi-Turuncu	

## ENDÜSTRİYEL PVC HAVA HORTUMLARI



OPC 01812  
OPC 01140



OPC 00814  
OPC 01016  
OPC 01218  
OPC 01623

KOD	ÖZELLİK	ÖLÇÜ	ÇALIŞMA BASINCI	RENK	UZUNLUK	STANDART	FİYAT
OPC 01812	PVC	8.0X12.0	6-12 BAR	ŞEFFAF	100 m	ISO-2398	
OPC 01140	PVC	10.0X14.0	6-12 BAR	ŞEFFAF	100 m	ISO-2398	
OPC 00814	PVC	8.0X14.0	6-20 BAR	SİYAH	100 m	ISO-2398	
OPC 01016	PVC	10.0X16.0	6-20 BAR	SİYAH	100 m	ISO-2398	
OPC 01218	PVC	12.5X18.5	6-20 BAR	SİYAH	100 m	ISO-2398	
OPC 01623	PVC	16.0X23.0	6-20 BAR	SİYAH	50 m	ISO-2398	



### OPT MH 100 MAKARALI HAVA HORTUMU



Otomatik Geri Toplama	
Malzeme	Hortum: Poliüretan Gövde: Plastik
Hortum Uzunluk:	12 m
Hortum Çapı:	8x12 mm
Çalışma Basıncı:	10 bar
Sabit Hortum Ucu:	1 m

### OPT MH 150 MAKARALI HAVA HORTUMU



Otomatik Geri Toplama	
Malzeme	Hortum: Poliüretan Gövde: Plastik
Hortum Uzunluk:	12 m
Hortum Çapı:	6,5x10 mm
Çalışma Basıncı:	10 bar
Sabit Hortum Ucu:	1 m

### OPT MK 165 MAKARALI UZATMA KABLO



Otomatik Geri Toplama	
Kablo Uzunluğu:	12 m
Gövde:	Plastik
Kablo Kesiti:	3x1.5 mm
Kablo Yapısı:	Kaçuk
Soket:	230 V 50-60 Hz
Sabit Kablo Ucu:	1 m

### OPT MK 250 MAKARALI UZATMA KABLO



Otomatik Geri Toplama	
Kablo Uzunluğu:	25 m
Gövde:	Plastik
Kablo Kesiti:	3x1.5 mm
Kablo Yapısı:	Kaçuk
Soket:	230 V 50-60 Hz
Sabit Kablo Ucu:	1 m

### OPT MH 200 MAKARALI HAVA HORTUMU



Otomatik Geri Toplama	
Malzeme	Hortum: Örgülü PVC Gövde: Plastik
Hortum Uzunluk:	20 m
Hortum Çapı:	10x16 mm
Çalışma Basıncı:	10 bar
Sabit Hortum Ucu:	1 m

### OPT MH 230 MAKARALI HAVA HORTUMU



Otomatik Geri Toplama	
Malzeme	Hortum: Örgülü PVC Gövde: Metal
Hortum Uzunluk:	20 m
Hortum Çapı:	9,5x14 mm
Çalışma Basıncı:	10 bar
Sabit Hortum Ucu:	1 m

### OPT MS 14 MAKARALI SU HORTUMU



Otomatik Geri Toplama	
Malzeme	Hortum: Örgülü PVC Gövde: Plastik
Hortum Uzunluk:	14 m
Hortum Çapı:	1/2"
Çalışma Basıncı:	6 bar
Sabit Hortum Ucu:	1 m

### OPT MS 20 MAKARALI SU HORTUMU



Otomatik Geri Toplama	
Malzeme	Hortum: Örgülü PVC Gövde: Plastik
Hortum Uzunluk:	20 m
Hortum Çapı:	1/2"
Çalışma Basıncı:	6 bar
Sabit Hortum Ucu:	1 m

### OPT MH 210 MAKARALI HAVA HORTUMU



Otomatik Geri Toplama	
Malzeme	Hortum: Örgülü PU Gövde: Metal
Hortum Uzunluk:	20 m
Hortum Çapı:	10x16 mm
Çalışma Basıncı:	12 bar
Sabit Kablo Ucu:	2 m
Ölçü:	49x24x52 cm

### OPT MH 220 MAKARALI HAVA HORTUMU



Otomatik Geri Toplama	
Malzeme	Hortum: Örgülü PU Gövde: Metal
Hortum Uzunluk:	15 m
Hortum Çapı:	12,5x18,5 mm
Çalışma Basıncı:	12 bar
Sabit Kablo Ucu:	2 m
Ölçü:	49x24x52 cm

### OPT MS 28 MAKARALI SU HORTUMU



Otomatik Geri Toplama	
Malzeme	Hortum: Örgülü PVC Gövde: Plastik
Hortum Uzunluk:	28 m
Hortum Çapı:	1/2"
Çalışma Basıncı:	6 bar
Sabit Hortum Ucu:	1 m





# TECNA®

Balanserler



### TECNA BALANSER



PLASTİK GÖVDE		
Kod	Kapasite / Uzunluk / Ağırlık	Fiyat
9301	0.4-1 kg / 1600 mm / 0.6 kg	
9302	1.0-2 kg / 1600 mm / 0.6 kg	
9303	2.0-3 kg / 1600 mm / 0.7 kg	



Kod	Kapasite / Uzunluk / Ağırlık	Fiyat
9311	0.4-1 kg / 1600 mm / 0.6 kg	
9312	1.0-2 kg / 1600 mm / 0.6 kg	
9313	2.0-3 kg / 1600 mm / 0.7 kg	



Kod	Kapasite / Uzunluk / Ağırlık	Fiyat
9321	2.0-4 kg / 2000 mm / 2.0 kg	
9322	4.0-6 kg / 2000 mm / 2.3 kg	
9323	6.0-8 kg / 2000 mm / 2.5 kg	



Kod	Kapasite / Uzunluk / Ağırlık	Fiyat
9336	2-4 kg / 2500 mm / 3.0 kg	
9339	8.0-10 kg / 2500 mm / 3.7 kg	
9340	10.0-14 kg / 2500 mm / 4.0 kg	

### TECNA BALANSER



Kod	Kapasite / Uzunluk / Ağırlık	Fiyat
9357	14-18 kg / 2000 mm / 6.0 kg	
9358	18-22 kg / 2000 mm / 6.5 kg	
9359	22-25 kg / 2000 mm / 6.5 kg	



Kod	Kapasite / Uzunluk / Ağırlık	Fiyat
9431	15-20 kg / 3000 mm / 19,1 kg	
9432	20-25 kg / 3000 mm / 19,9 kg	
9433	25-35 kg / 3000 mm / 20,9 kg	



Kod	Kapasite / Uzunluk / Ağırlık	Fiyat
9362	15-20 kg / 2000 mm / 10.5 kg	
9363	20-25 kg / 2000 mm / 11.0 kg	
9364	25-30 kg / 2000 mm / 11.5 kg	
9365	30-35 kg / 2000 mm / 11.8 kg	
9366	35-45 kg / 2000 mm / 12.4 kg	
9367	45-55 kg / 2000 mm / 12.5 kg	
9368	55-65 kg / 2000 mm / 13.6 kg	
9369	65-75 kg / 2000 mm / 14.5 kg	



STOPLU		
Kod	Kapasite / Uzunluk / Ağırlık	Fiyat
9346	2.0-4 kg / 2500 mm / 3.0 kg	
9347	4.0-6 kg / 2500 mm / 3.3 kg	
9348	6.0-8 kg / 2500 mm / 3.6 kg	
9349	8.0-10 kg / 2500 mm / 3.8 kg	
9350	10.0-14 kg / 2500 mm / 4.0 kg	



### TECNA BALANSER

Kod	Kapasite / Uzunluk / Ağırlık	Fiyat
9434	35-45 kg / 3000 mm / 23,8 kg	
9435	40-50 kg / 3000 mm / 25,3 kg	
9436	50-60 kg / 3000 mm / 25,0 kg	
9441	60-70 kg / 3000 mm / 27,0 kg	
9442	70-80 kg / 3000 mm / 27,0 kg	
9444	80-100 kg / 3000 mm / 27,0 kg	



Kod	Kapasite / Uzunluk / Ağırlık	Fiyat
9403	30-40 kg / 2500 mm / 28 kg	
9412	70-80 kg / 2500 mm / 35 kg	
9422	100-120 kg / 2500 mm / 38,7 kg	
9423	120-140 kg / 2500 mm / 41,9 kg	
9425	140-160 kg / 2500 mm / 44,6 kg	
9426	160-180 kg / 2500 mm / 49,0 kg	
9451	100-115 kg / 3000 mm / 39,7 kg	



Kod	Kapasite / Uzunluk / Ağırlık	Fiyat
9200	0,40-80 kg / 1350 mm / 1,35 kg	
9201	0,75-1,5 kg / 1350 mm / 1,35 kg	
9202	1,2-2,5 kg / 1350 mm / 1,25 kg	
9203	3-5 kg / 900 mm / 1,40 kg	



Kod	Kapasite / Uzunluk / Ağırlık	Fiyat
9370	75-90 kg / 2000 mm / 17,3 kg	
9371	90-105 kg / 2000 mm / 18,0 kg	



Kod	Kapasite / Uzunluk / Ağırlık	Fiyat
OPT 15	0,6-1,5 kg / 1,5 mt	
OPT 30	1,5-3,0 kg / 1,5 mt	







**OSAKA**<sup>®</sup> [www.osaka.com.tr](http://www.osaka.com.tr)

Lokmalar



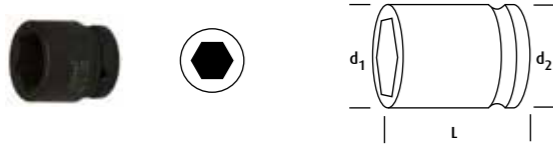

### LOKMA 1/4"

Model	Boyut	Malzeme	İç Çap (mm)	İç Çap (inç)	Çap (mm)	Çap (inç)	Uzunluk (mm)	Uzunluk (inç)	Fiyat USD
LN14S04	1/4"	CR-MO	4 mm	7.7	13	25			
LN14S045	1/4"	CR-MO	4.5 mm	8.3	13	25			
LN14S05	1/4"	CR-MO	5 mm	9	13	25			
LN14S055	1/4"	CR-MO	5.5 mm	9.6	13	25			
LN14S06	1/4"	CR-MO	6 mm	10.2	13	25			
LN14S07	1/4"	CR-MO	7 mm	11.5	13	25			
LN14S08	1/4"	CR-MO	8 mm	12.8	13	25			
LN14S09	1/4"	CR-MO	9 mm	14	13	25			
LN14S10	1/4"	CR-MO	10 mm	14.5	13	25			
LN14S11	1/4"	CR-MO	11 mm	16.6	13	25			
LN14S12	1/4"	CR-MO	12 mm	17.7	13	25			
LN14S13	1/4"	CR-MO	13 mm	19	13	25			
LN14S14	1/4"	CR-MO	14 mm	20	13	25			



### UZUN LOKMA 1/4"

Model	Boyut	Malzeme	İç Çap (mm)	İç Çap (inç)	Çap (mm)	Çap (inç)	Uzunluk (mm)	Uzunluk (inç)	Fiyat USD
LN14D04	1/4"	CR-MO	4 mm	7.7	13	50			
LN14D045	1/4"	CR-MO	4.5 mm	8.3	13	50			
LN14D05	1/4"	CR-MO	5 mm	9	13	50			
LN14D055	1/4"	CR-MO	5.5 mm	9.6	13	50			
LN14D06	1/4"	CR-MO	6 mm	10.2	13	50			
LN14D07	1/4"	CR-MO	7 mm	10.3	13	50			
LN14D08	1/4"	CR-MO	8 mm	11.5	13	50			
LN14D09	1/4"	CR-MO	9 mm	12.8	13	50			
LN14D10	1/4"	CR-MO	10 mm	14	13	50			
LN14D11	1/4"	CR-MO	11 mm	14.5	13	50			
LN14D12	1/4"	CR-MO	12 mm	16.6	13	50			
LN14D13	1/4"	CR-MO	13 mm	17.7	13	50			
LN14D14	1/4"	CR-MO	14 mm	19	13	50			



### LOKMA 3/8"

Model	Boyut	Malzeme	İç Çap (mm)	İç Çap (inç)	Çap (mm)	Çap (inç)	Uzunluk (mm)	Uzunluk (inç)	Fiyat USD
LN38S06	3/8"	CR-MO	6 mm	11	19	30			
LN38S07	3/8"	CR-MO	7 mm	12.8	19	30			
LN38S08	3/8"	CR-MO	8 mm	14	19	30			
LN38S09	3/8"	CR-MO	9 mm	15.2	19	30			
LN38S10	3/8"	CR-MO	10 mm	15.9	19	30			
LN38S11	3/8"	CR-MO	11 mm	17.7	19	30			
LN38S12	3/8"	CR-MO	12 mm	19	19	30			
LN38S13	3/8"	CR-MO	13 mm	20.2	22	30			
LN38S14	3/8"	CR-MO	14 mm	21.5	22	30			
LN38S15	3/8"	CR-MO	15 mm	22.6	22	30			
LN38S16	3/8"	CR-MO	16 mm	24	22	30			
LN38S17	3/8"	CR-MO	17 mm	25.2	22	30			
LN38S18	3/8"	CR-MO	18 mm	26.5	22	30			
LN38S19	3/8"	CR-MO	19 mm	27.7	22	30			
LN38S20	3/8"	CR-MO	20 mm	28.5	22	30			
LN38S21	3/8"	CR-MO	21 mm	30	22	30			
LN38S22	3/8"	CR-MO	22 mm	32	22	30			



### YILDIZ LOKMA 3/8"

Model	Boyut	Malzeme	İç Çap (mm)	İç Çap (inç)	Çap (mm)	Çap (inç)	Uzunluk (mm)	Uzunluk (inç)	Fiyat USD
LN38Y06	3/8"	CR-MO	6 mm	11	19	30			
LN38Y07	3/8"	CR-MO	7 mm	12.8	19	30			
LN38Y08	3/8"	CR-MO	8 mm	14	19	30			
LN38Y09	3/8"	CR-MO	9 mm	15.2	19	30			
LN38Y10	3/8"	CR-MO	10 mm	15.9	19	30			
LN38Y11	3/8"	CR-MO	11 mm	17.7	19	30			
LN38Y12	3/8"	CR-MO	12 mm	19	19	30			
LN38Y13	3/8"	CR-MO	13 mm	20.2	22	30			
LN38Y14	3/8"	CR-MO	14 mm	21.5	22	30			
LN38Y15	3/8"	CR-MO	15 mm	22.6	22	30			
LN38Y16	3/8"	CR-MO	16 mm	24	22	30			
LN38Y17	3/8"	CR-MO	17 mm	25.2	22	30			
LN38Y18	3/8"	CR-MO	18 mm	26.5	22	30			
LN38Y19	3/8"	CR-MO	19 mm	27.7	22	30			
LN38Y20	3/8"	CR-MO	20 mm	28.5	22	30			
LN38Y21	3/8"	CR-MO	21 mm	30	22	30			
LN38Y22	3/8"	CR-MO	22 mm	32	22	30			

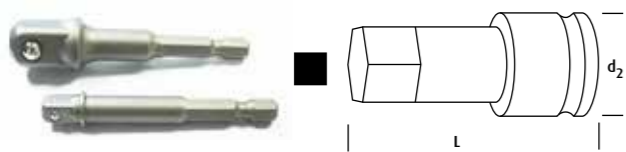

### ADAPTÖR 1/4"

Model	Boyut	Malzeme	Çap (mm)	Çap (inç)	Uzunluk (mm)	Uzunluk (inç)	Fiyat USD
LN14-14AD	1/4"	CR-MO					
LN14-38AD	3/8"	CR-MO					

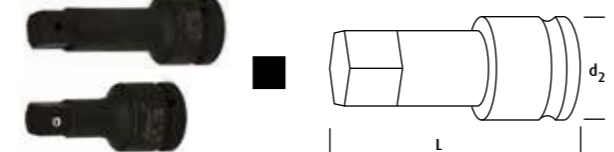

### UZATMA 1/4"

Model	Boyut	Malzeme	Uzunluk (mm)	Uzunluk (inç)	Fiyat USD
LN14U050	1/4"	CR-MO	2"	50	
LN14U075	1/4"	CR-MO	3"	75	

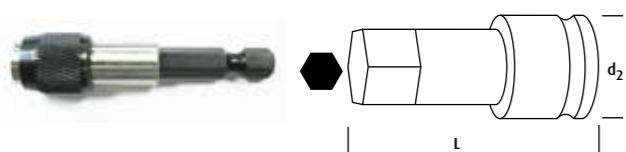

### ADAPTÖR 1/4"

Model	Boyut	Malzeme	Çap (mm)	Çap (inç)	Uzunluk (mm)	Uzunluk (inç)	Fiyat USD
LN14-14BAD	1/4"	CR-MO			75		

### UZUN LOKMA 3/8"

Model	Boyut	Malzeme	İç Çap (mm)	İç Çap (inç)	Çap (mm)	Çap (inç)	Uzunluk (mm)	Uzunluk (inç)	Fiyat USD
LN38D06	3/8"	CR-MO	6 mm	11	19	63			
LN38D07	3/8"	CR-MO	7 mm	12.8	19	63			
LN38D08	3/8"	CR-MO	8 mm	14	19	63			
LN38D09	3/8"	CR-MO	9 mm	15.2	19	63			
LN38D10	3/8"	CR-MO	10 mm	15.9	19	63			
LN38D11	3/8"	CR-MO	11 mm	17.7	19	63			
LN38D12	3/8"	CR-MO	12 mm	19	19	63			
LN38D13	3/8"	CR-MO	13 mm	20.2	22	63			
LN38D14	3/8"	CR-MO	14 mm	21.5	22	63			
LN38D15	3/8"	CR-MO	15 mm	22.6	22	63			
LN38D16	3/8"	CR-MO	16 mm	24	22	63			
LN38D17	3/8"	CR-MO	17 mm	25.2	22	63			
LN38D18	3/8"	CR-MO	18 mm	26.5	22	63			
LN38D19	3/8"	CR-MO	19 mm	27.7	22	63			
LN38D20	3/8"	CR-MO	20 mm	28.5	22	63			
LN38D21	3/8"	CR-MO	21 mm	30	22	63			
LN38D22	3/8"	CR-MO	22 mm	32	22	63			



### YILDIZ UZUN LOKMA 3/8"

Model	Boyut	Malzeme	İç Çap (mm)	İç Çap (inç)	Çap (mm)	Çap (inç)	Uzunluk (mm)	Uzunluk (inç)	Fiyat USD
LN38YD06	3/8"	CR-MO	6 mm	11	19	63			
LN38YD07	3/8"	CR-MO	7 mm	12.8	19	63			
LN38YD08	3/8"	CR-MO	8 mm	14	19	63			
LN38YD09	3/8"	CR-MO	9 mm	15.2	19	63			
LN38YD10	3/8"	CR-MO	10 mm	15.9	19	63			
LN38YD11	3/8"	CR-MO	11 mm	17.7	19	63			
LN38YD12	3/8"	CR-MO	12 mm	19	19	63			
LN38YD13	3/8"	CR-MO	13 mm	20.2	22	63			
LN38YD14	3/8"	CR-MO	14 mm	21.5	22	63			
LN38YD15	3/8"	CR-MO	15 mm	22.6	22	63			
LN38YD16	3/8"	CR-MO	16 mm	24	22	63			
LN38YD17	3/8"	CR-MO	17 mm	25.2	22	63			
LN38YD18	3/8"	CR-MO	18 mm	26.5	22	63			
LN38YD19	3/8"	CR-MO	19 mm	27.7	22	63			
LN38YD20	3/8"	CR-MO	20 mm	28.5	22	63			
LN38YD21	3/8"	CR-MO	21 mm	30	22	63			
LN38YD22	3/8"	CR-MO	22 mm	32	22	63			

### IMPULSE LOKMA 3/8"

Model	Boyut	Malzeme	İç Çap (mm)	İç Çap (inç)	Çap (mm)	Çap (inç)	Uzunluk (mm)	Uzunluk (inç)	Fiyat USD
LN38P08	3/8"	CR-MO	8 mm	13	19	43			
LN38P09	3/8"	CR-MO	9 mm	15	19	43			
LN38P10	3/8"	CR-MO	10 mm	16	19	43			
LN38P11	3/8"	CR-MO	11 mm	17.5	19	43			
LN38P12	3/8"	CR-MO	12 mm	18.5	19	43			
LN38P13	3/8"	CR-MO	13 mm	20	22	43			
LN38P14	3/8"	CR-MO	14 mm	21	22	43			
LN38P15	3/8"	CR-MO	15 mm	22	22	43			
LN38P16	3/8"	CR-MO	16 mm	24	22	43			
LN38P17	3/8"	CR-MO	17 mm	25	22	43			
LN38P18	3/8"	CR-MO	18 mm	26	22	43			
LN38P19	3/8"	CR-MO	19 mm	27	22	43			



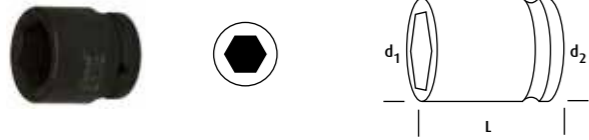

### INCH LOKMA 3/8"

Model	Boyut	Malzeme	Uzunluk	d1	d2	L	Fiyat USD
LN38I1/4	3/8"	CR-MO	1 / 4	11	18	30	
LN38I5/16	3/8"	CR-MO	5 / 16	12.5	18	30	
LN38I3/8	3/8"	CR-MO	3 / 8	15	18	30	
LN38I7/16	3/8"	CR-MO	7 / 16	17	18	30	
LN38I1/2	3/8"	CR-MO	1 / 2	20	20	30	
LN38I9/16	3/8"	CR-MO	9 / 16	22	22	30	
LN38I5/8	3/8"	CR-MO	5 / 8	24	24	30	
LN38I11/16	3/8"	CR-MO	11 / 16	26	26	30	
LN38I3/4	3/8"	CR-MO	3 / 4	27	27	30	
LN38I13/16	3/8"	CR-MO	13 / 16	30	30	30	
LN38I7/8	3/8"	CR-MO	7 / 8	32	32	30	

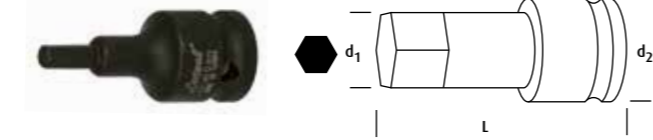

### ALLEN LOKMA 3/8"

Model	Boyut	Malzeme	Uzunluk	d1	d2	L	Fiyat USD
LN38A03	3/8"	CR-MO	3 mm	6	25	50	
LN38A04	3/8"	CR-MO	4 mm	6	25	50	
LN38A05	3/8"	CR-MO	5 mm	6	25	50	
LN38A06	3/8"	CR-MO	6 mm	11	25	50	
LN38A08	3/8"	CR-MO	8 mm	11	25	50	
LN38A10	3/8"	CR-MO	10 mm	11	25	50	
LN38A12	3/8"	CR-MO	12 mm	14	25	50	
LN38A14	3/8"	CR-MO	14 mm	16	25	50	
LN38A17	3/8"	CR-MO	17 mm	20	25	50	



### LOKMA 1/2"

Model	Boyut	Malzeme	Uzunluk	d1	d2	L	Fiyat USD
LN12S08	1/2"	CR-MO	8 mm	15	24	38	
LN12S09	1/2"	CR-MO	9 mm	16	24	38	
LN12S10	1/2"	CR-MO	10 mm	17.5	24	38	
LN12S11	1/2"	CR-MO	11 mm	18.5	24	38	
LN12S12	1/2"	CR-MO	12 mm	19.5	24	38	
LN12S13	1/2"	CR-MO	13 mm	20.5	24	38	
LN12S14	1/2"	CR-MO	14 mm	22	24	38	
LN12S15	1/2"	CR-MO	15 mm	24	24	38	
LN12S16	1/2"	CR-MO	16 mm	24	24	38	
LN12S17	1/2"	CR-MO	17 mm	26	26	38	
LN12S18	1/2"	CR-MO	18 mm	28	28	38	
LN12S19	1/2"	CR-MO	19 mm	28	30	38	
LN12S20	1/2"	CR-MO	20 mm	30	30	38	
LN12S21	1/2"	CR-MO	21 mm	30	30	38	
LN12S22	1/2"	CR-MO	22 mm	32	30	38	
LN12S23	1/2"	CR-MO	23 mm	34	30	38	
LN12S24	1/2"	CR-MO	24 mm	34	30	38	
LN12S25	1/2"	CR-MO	25 mm	36	30	38	
LN12S26	1/2"	CR-MO	26 mm	36	30	38	
LN12S27	1/2"	CR-MO	27 mm	38	30	38	
LN12S28	1/2"	CR-MO	28 mm	40	30	42	
LN12S29	1/2"	CR-MO	29 mm	42	30	42	
LN12S30	1/2"	CR-MO	30 mm	42	30	42	
LN12S32	1/2"	CR-MO	32 mm	44	30	42	

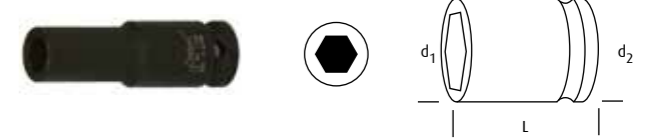

### UZUN LOKMA 1/2"

Model	Boyut	Malzeme	Uzunluk	d1	d2	L	Fiyat USD
LN12D08	1/2"	CR-MO	8 mm	14	24	78	
LN12D09	1/2"	CR-MO	9 mm	16	24	78	
LN12D10	1/2"	CR-MO	10 mm	17.5	24	78	
LN12D11	1/2"	CR-MO	11 mm	18.5	24	78	
LN12D12	1/2"	CR-MO	12 mm	19.5	24	78	
LN12D13	1/2"	CR-MO	13 mm	20.5	24	78	
LN12D14	1/2"	CR-MO	14 mm	22	24	78	
LN12D15	1/2"	CR-MO	15 mm	24	24	78	
LN12D16	1/2"	CR-MO	16 mm	24	24	78	
LN12D17	1/2"	CR-MO	17 mm	26	26	78	
LN12D18	1/2"	CR-MO	18 mm	28	28	78	
LN12D19	1/2"	CR-MO	19 mm	28	30	78	
LN12D20	1/2"	CR-MO	20 mm	30	30	78	
LN12D21	1/2"	CR-MO	21 mm	30	30	78	
LN12D22	1/2"	CR-MO	22 mm	32	30	78	
LN12D23	1/2"	CR-MO	23 mm	34	30	78	
LN12D24	1/2"	CR-MO	24 mm	34	30	78	
LN12D25	1/2"	CR-MO	25 mm	36	30	78	
LN12D26	1/2"	CR-MO	26 mm	36	30	78	
LN12D27	1/2"	CR-MO	27 mm	38	30	78	
LN12D28	1/2"	CR-MO	28 mm	40	30	78	
LN12D29	1/2"	CR-MO	29 mm	42	30	78	
LN12D30	1/2"	CR-MO	30 mm	42	30	78	
LN12D32	1/2"	CR-MO	32 mm	44	30	78	

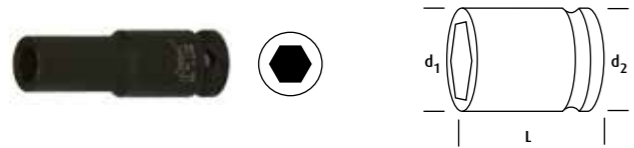

### INCH UZUN LOKMA 3/8"

Model	Boyut	Malzeme	Uzunluk	d1	d2	L	Fiyat USD
LN38ID1/4	3/8"	CR-MO	1 / 4	11	18	63	
LN38ID5/16	3/8"	CR-MO	5 / 16	12.5	18	63	
LN38ID3/8	3/8"	CR-MO	3 / 8	15	18	63	
LN38ID7/16	3/8"	CR-MO	7 / 16	17	18	63	
LN38ID1/2	3/8"	CR-MO	1 / 2	20	20	63	
LN38ID9/16	3/8"	CR-MO	9 / 16	22	22	63	
LN38ID5/8	3/8"	CR-MO	5 / 8	24	24	63	
LN38ID11/16	3/8"	CR-MO	11 / 16	26	26	63	
LN38ID3/4	3/8"	CR-MO	3 / 4	27	27	63	
LN38ID13/16	3/8"	CR-MO	13 / 16	30	30	63	
LN38ID7/8	3/8"	CR-MO	7 / 8	32	32	63	

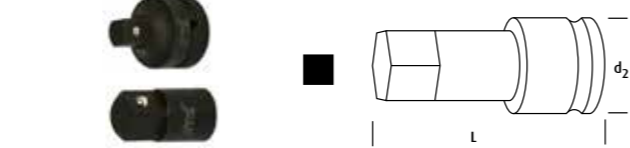

### ADAPTÖR 3/8"

Model	Boyut	Malzeme	d1	d2	L	Fiyat USD
LN12-38AD	1/2"-3/8"	CR-MO		25	36	
LN38-14AD	3/8"-1/4"	CR-MO		25	36	
LN38-12AD	3/8"-1/2"	CR-MO		30	38	

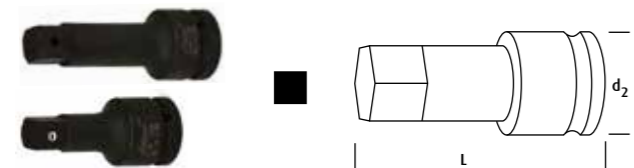

### UZATMA 3/8"

Model	Boyut	Malzeme	Uzunluk	d1	d2	L	Fiyat USD
LN38U075	3/8"	CR-MO	3"		18	75	
LN38U125	3/8"	CR-MO	5"		18	125	
LN38U150	3/8"	CR-MO	6"		18	150	

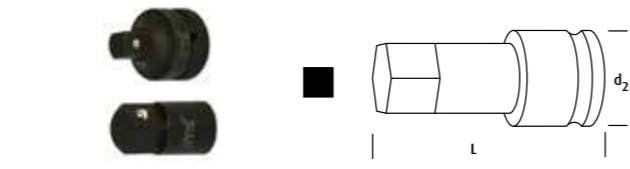

### MAFSAL 3/8"

Model	Boyut	Malzeme	d1	d2	L	Fiyat USD
LN38M38	3/8"-3/8"	CR-MO		18	50	

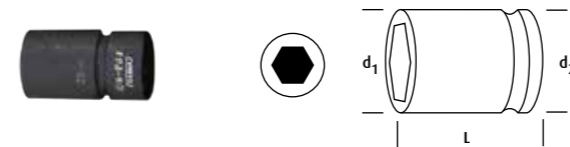

### IMPULSE LOKMA 1/2"

Model	Boyut	Malzeme	Uzunluk	d1	d2	L	Fiyat USD
LN12P10	1/2"	CR-MO	10 mm	17.5	25	52	
LN12P11	1/2"	CR-MO	11 mm	18.5	25	52	
LN12P12	1/2"	CR-MO	12 mm	20	25	52	
LN12P13	1/2"	CR-MO	13 mm	21	25	52	
LN12P14	1/2"	CR-MO	14 mm	22.5	25	52	
LN12P15	1/2"	CR-MO	15 mm	23.5	30	52	
LN12P16	1/2"	CR-MO	16 mm	25	30	52	
LN12P17	1/2"	CR-MO	17 mm	26	30	52	
LN12P18	1/2"	CR-MO	18 mm	27.5	30	52	
LN12P19	1/2"	CR-MO	19 mm	28.5	30	52	
LN12P20	1/2"	CR-MO	20 mm	30	30	52	
LN12P21	1/2"	CR-MO	21 mm	31	30	52	
LN12P22	1/2"	CR-MO	22 mm	32	30	52	





### YILDIZ LOKMA 1/2"

Model	Boyut	Malzeme	Yarıçap	d1	d2	L	Fiyat USD
LN12Y08	1/2"	CR-MO	8 mm	15	38	38	
LN12Y09	1/2"	CR-MO	9 mm	16	38	38	
LN12Y10	1/2"	CR-MO	10 mm	17.5	38	38	
LN12Y11	1/2"	CR-MO	11 mm	18.5	38	38	
LN12Y12	1/2"	CR-MO	12 mm	19.5	38	38	
LN12Y13	1/2"	CR-MO	13 mm	20.5	38	38	
LN12Y14	1/2"	CR-MO	14 mm	22	38	38	
LN12Y15	1/2"	CR-MO	15 mm	24	38	38	
LN12Y16	1/2"	CR-MO	16 mm	24	38	38	
LN12Y17	1/2"	CR-MO	17 mm	26	38	38	
LN12Y18	1/2"	CR-MO	18 mm	28	38	38	
LN12Y19	1/2"	CR-MO	19 mm	28	38	38	
LN12Y20	1/2"	CR-MO	20 mm	30	38	38	
LN12Y21	1/2"	CR-MO	21 mm	30	38	38	
LN12Y22	1/2"	CR-MO	22 mm	32	38	38	
LN12Y23	1/2"	CR-MO	23 mm	34	38	38	
LN12Y24	1/2"	CR-MO	24 mm	34	38	38	
LN12Y25	1/2"	CR-MO	25 mm	36	38	38	
LN12Y26	1/2"	CR-MO	26 mm	36	38	38	
LN12Y27	1/2"	CR-MO	27 mm	38	38	38	
LN12Y28	1/2"	CR-MO	28 mm	40	42	42	
LN12Y29	1/2"	CR-MO	29 mm	42	42	42	
LN12Y30	1/2"	CR-MO	30 mm	42	42	42	
LN12Y32	1/2"	CR-MO	32 mm	44	42	42	



### INCH LOKMA 1/2"

Model	Boyut	Malzeme	Yarıçap	d1	d2	L	Fiyat USD
LN12I5/16	1/2"	CR-MO	5/16	15	24	38	
LN12I3/8	1/2"	CR-MO	3/8	16	24	38	
LN12I7/16	1/2"	CR-MO	7/16	17	24	38	
LN12I1/2	1/2"	CR-MO	1/2	18	24	38	
LN12I9/16	1/2"	CR-MO	9/16	19	24	38	
LN12I5/8	1/2"	CR-MO	5/8	24	24	38	
LN12I11/16	1/2"	CR-MO	11/16	26	24	38	
LN12I3/4	1/2"	CR-MO	3/4	28	24	38	
LN12I13/16	1/2"	CR-MO	13/16	30	24	38	
LN12I7/8	1/2"	CR-MO	7/8	32	24	38	
LN12I15/16	1/2"	CR-MO	15/16	34	26	38	
LN12I1-1/16	1/2"	CR-MO	1-1/16	38	26	38	
LN12I1-1/8	1/2"	CR-MO	1-1/8	42	30	38	
LN12I1-3/16	1/2"	CR-MO	1-3/16	42	30	38	
LN12I1-1/4	1/2"	CR-MO	1-1/4	44	30	38	



### INCH UZUN LOKMA 1/2"

Model	Boyut	Malzeme	Yarıçap	d1	d2	L	Fiyat USD
LN12ID5/16	1/2"	CR-MO	5/16	15	24	78	
LN12ID3/8	1/2"	CR-MO	3/8	16	24	78	
LN12ID7/16	1/2"	CR-MO	7/16	17	24	78	
LN12ID1/2	1/2"	CR-MO	1/2	18	24	78	
LN12ID9/16	1/2"	CR-MO	9/16	19	24	78	
LN12ID5/8	1/2"	CR-MO	5/8	24	24	78	
LN12ID11/16	1/2"	CR-MO	11/16	26	24	78	
LN12ID3/4	1/2"	CR-MO	3/4	28	24	78	
LN12ID13/16	1/2"	CR-MO	13/16	30	24	78	
LN12ID7/8	1/2"	CR-MO	7/8	32	24	78	
LN12ID15/16	1/2"	CR-MO	15/16	34	26	78	
LN12ID1-1/16	1/2"	CR-MO	1-1/16	38	26	78	
LN12ID1-1/8	1/2"	CR-MO	1-1/8	42	30	78	
LN12ID1-3/16	1/2"	CR-MO	1-3/16	42	30	78	
LN12ID1-1/4	1/2"	CR-MO	1-1/4	44	30	78	

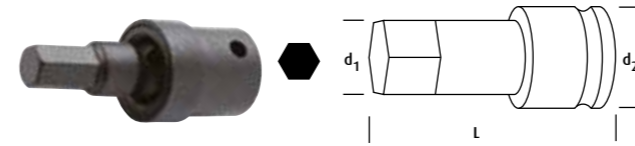

### MAFSALLI ALLEN LOKMA 1/2"

Model	Boyut	Malzeme	Yarıçap	d1	d2	L	Fiyat USD
LN12MA06	1/2"	CR-MO	6 mm	6	25	74	
LN12MA08	1/2"	CR-MO	8 mm	6	25	74	
LN12MA10	1/2"	CR-MO	10 mm	11	25	74	
LN12MA12	1/2"	CR-MO	12 mm	11	25	74	
LN12MA14	1/2"	CR-MO	14 mm	11	25	74	
LN12MA17	1/2"	CR-MO	17 mm	14	25	74	
LN12MA19	1/2"	CR-MO	19 mm	16	25	74	

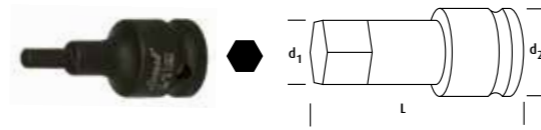

### ALLEN LOKMA 1/2"

Model	Boyut	Malzeme	Yarıçap	d1	d2	L	Fiyat USD
LN12A04	1/2"	CR-MO	4 mm	6	25	60	
LN12A05	1/2"	CR-MO	5 mm	6	25	60	
LN12A06	1/2"	CR-MO	6 mm	11	25	60	
LN12A08	1/2"	CR-MO	8 mm	11	25	60	
LN12A10	1/2"	CR-MO	10 mm	11	25	60	
LN12A12	1/2"	CR-MO	12 mm	14	25	60	
LN12A14	1/2"	CR-MO	14 mm	16	25	60	
LN12A17	1/2"	CR-MO	17 mm	18	25	60	
LN12A19	1/2"	CR-MO	19 mm	20	25	60	

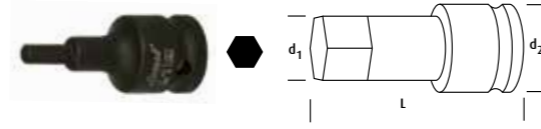

### STAR ALLEN UZUN LOKMA 1/2"

Model	Boyut	Malzeme	Yarıçap	d1	d2	L	Fiyat USD
LN12SA04	1/2"	CR-MO	4 mm	6	25	78	
LN12SA05	1/2"	CR-MO	5 mm	6	25	78	
LN12SA06	1/2"	CR-MO	6 mm	11	25	78	
LN12SA08	1/2"	CR-MO	8 mm	11	25	78	
LN12SA10	1/2"	CR-MO	10 mm	11	25	78	
LN12SA12	1/2"	CR-MO	12 mm	14	25	78	
LN12SA14	1/2"	CR-MO	14 mm	16	25	78	
LN12SA16	1/2"	CR-MO	16 mm	18	25	78	
LN12SA18	1/2"	CR-MO	18 mm	20	25	78	

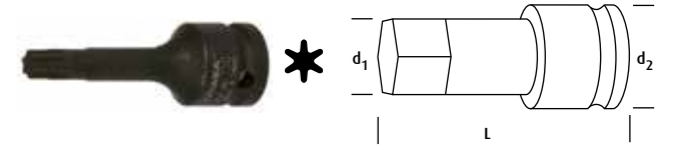

### TORKS LOKMA 1/2"

Model	Boyut	Malzeme	Yarıçap	d1	d2	L	Fiyat USD
LN12T20	1/2"	CR-MO	T20	10	25	78	
LN12T25	1/2"	CR-MO	T25	10	25	78	
LN12T27	1/2"	CR-MO	T27	10	25	78	
LN12T30	1/2"	CR-MO	T30	10	25	78	
LN12T35	1/2"	CR-MO	T35	10	25	78	
LN12T40	1/2"	CR-MO	T40	10	25	78	
LN12T45	1/2"	CR-MO	T45	10	25	78	
LN12T50	1/2"	CR-MO	T50	10	25	78	
LN12T55	1/2"	CR-MO	T55	11	25	78	
LN12T60	1/2"	CR-MO	T60	12	25	78	
LN12T80	1/2"	CR-MO	T80	12	25	78	



### DIŞİ TORKS LOKMA 1/2"

Model	Boyut	Malzeme	Yarıçap	d1	d2	L	Fiyat USD
LN12E10	1/2"	CR-MO	E10	13.5	25	38	
LN12E12	1/2"	CR-MO	E12	15.5	25	38	
LN12E14	1/2"	CR-MO	E14	17.5	25	38	
LN12E16	1/2"	CR-MO	E16	19.6	25	38	
LN12E18	1/2"	CR-MO	E18	21.8	25	38	
LN12E20	1/2"	CR-MO	E20	23.8	25	38	
LN12E22	1/2"	CR-MO	E22	25.8	25	38	
LN12E24	1/2"	CR-MO	E24	28.3	25	38	



### DIŞİ TORKS LOKMA 3/4"

Model	Boyut	Malzeme	Yarıçap	d1	d2	L	Fiyat USD
LN34E22	3/4"	CR-MO	E22	36	44	57	
LN34E24	3/4"	CR-MO	E24	38.8	44	57	
LN34E26	3/4"	CR-MO	E26	41.3	44	57	
LN34E28	3/4"	CR-MO	E28	44	44	57	

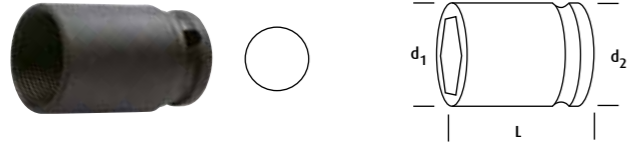

### TAMİR LOKMA 1/2"

Model	Boyut	Malzeme	Uzunluk (mm)	d1	d2	L	Fiyat USD
LN12N17	1/2"	CR-MO	17 mm	23	25	55	
LN12N185	1/2"	CR-MO	18.5 mm	25	25	55	
LN12N20	1/2"	CR-MO	20 mm	26	25	55	
LN12N215	1/2"	CR-MO	21.5 mm	28	30	55	
LN12N23	1/2"	CR-MO	23 mm	30	30	55	
LN12N245	1/2"	CR-MO	24.5 mm	30.5	30	55	
LN12N26	1/2"	CR-MO	26 mm	32	30	55	
LN12N275	1/2"	CR-MO	27.5 mm	33	30	55	

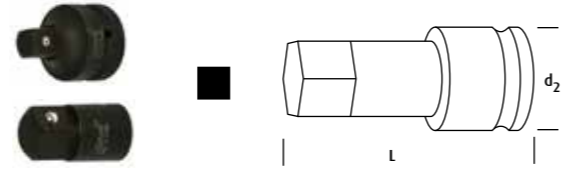

### ADAPTÖR 1/2"

Model	Boyut	Malzeme	d1	d2	L	Fiyat USD
LN12-38AD	1 / 2"-3/8"	CR-MO		25	38	
LN12-34AD	1 / 2"-3/4"	CR-MO		30	48	
LN38-12AD	3/8"-1/2"	CR-MO		30	48	

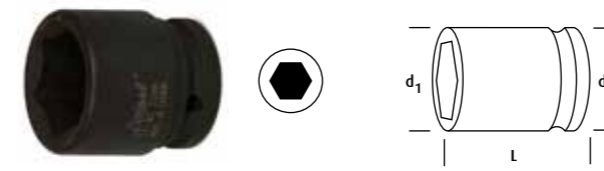

### LOKMA 3/4"

Model	Boyut	Malzeme	Uzunluk (mm)	d1	d2	L	Fiyat USD
LN34S17	3/4"	CR-MO	17 mm	30.1	44	51	
LN34S18	3/4"	CR-MO	18 mm	31.4	44	51	
LN34S19	3/4"	CR-MO	19 mm	32.6	44	51	
LN34S20	3/4"	CR-MO	20 mm	33.8	44	51	
LN34S21	3/4"	CR-MO	21 mm	35.1	44	51	
LN34S22	3/4"	CR-MO	22 mm	36.6	44	51	
LN34S23	3/4"	CR-MO	23 mm	37.9	44	54	
LN34S24	3/4"	CR-MO	24 mm	38.9	44	57	
LN34S25	3/4"	CR-MO	25 mm	40.1	44	57	
LN34S26	3/4"	CR-MO	26 mm	41.3	44	57	
LN34S27	3/4"	CR-MO	27 mm	42.6	44	57	
LN34S28	3/4"	CR-MO	28 mm	44	44	57	
LN34S29	3/4"	CR-MO	29 mm	45.1	44	58	
LN34S30	3/4"	CR-MO	30 mm	46.4	44	58	
LN34S32	3/4"	CR-MO	32 mm	48.9	44	58	
LN34S33	3/4"	CR-MO	33 mm	50.6	44	58	
LN34S34	3/4"	CR-MO	34 mm	51.4	44	58	
LN34S35	3/4"	CR-MO	35 mm	52.7	44	58	
LN34S36	3/4"	CR-MO	36 mm	53.9	44	58	
LN34S38	3/4"	CR-MO	38 mm	56.4	44	58	
LN34S41	3/4"	CR-MO	41 mm	60.1	44	58	
LN34S44	3/4"	CR-MO	44 mm	66.4	44	58	
LN34S46	3/4"	CR-MO	46 mm	66.4	44	58	
LN34S50	3/4"	CR-MO	50 mm	71.4	54	68	
LN34S55	3/4"	CR-MO	55 mm	77.7	54	73	
LN34S60	3/4"	CR-MO	60 mm	84.1	54	75	
LN34S65	3/4"	CR-MO	65 mm	90.2	54	78	
LN34S70	3/4"	CR-MO	70 mm	96.4	54	84	

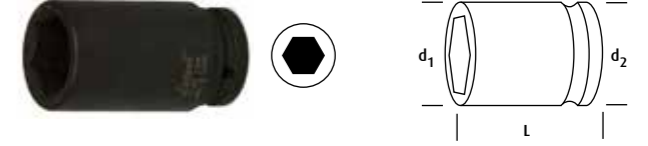

### UZUN LOKMA 3/4"

Model	Boyut	Malzeme	Uzunluk (mm)	d1	d2	L	Fiyat USD
LN34D17	3/4"	CR-MO	17 mm	30.1	44	90	
LN34D18	3/4"	CR-MO	18 mm	31.4	44	90	
LN34D19	3/4"	CR-MO	19 mm	32.6	44	90	
LN34D20	3/4"	CR-MO	20 mm	33.8	44	90	
LN34D21	3/4"	CR-MO	21 mm	35.1	44	90	
LN34D22	3/4"	CR-MO	22 mm	36.6	44	90	
LN34D23	3/4"	CR-MO	23 mm	37.9	44	90	
LN34D24	3/4"	CR-MO	24 mm	38.9	44	90	
LN34D25	3/4"	CR-MO	25 mm	40.1	44	90	
LN34D26	3/4"	CR-MO	26 mm	41.3	44	90	
LN34D27	3/4"	CR-MO	27 mm	42.6	44	90	
LN34D28	3/4"	CR-MO	28 mm	44	44	90	
LN34D29	3/4"	CR-MO	29 mm	45.1	44	90	
LN34D30	3/4"	CR-MO	30 mm	46.4	44	90	
LN34D32	3/4"	CR-MO	32 mm	48.9	44	90	
LN34D33	3/4"	CR-MO	33 mm	50.6	44	90	
LN34D34	3/4"	CR-MO	34 mm	51.4	44	90	
LN34D35	3/4"	CR-MO	35 mm	52.7	44	90	
LN34D36	3/4"	CR-MO	36 mm	53.9	44	90	
LN34D38	3/4"	CR-MO	38 mm	56.4	44	90	
LN34D41	3/4"	CR-MO	41 mm	60.1	44	90	
LN34D46	3/4"	CR-MO	46 mm	66.4	44	90	
LN34D50	3/4"	CR-MO	50 mm	71.4	54	90	
LN34D55	3/4"	CR-MO	55 mm	76.4	54	90	

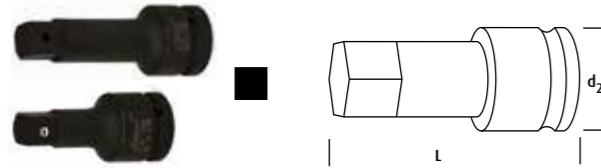

### UZATMA 1/2"

Model	Boyut	Malzeme	Uzunluk (mm)	d1	d2	L	Fiyat USD
LN12U075	1/2"	CR-MO	3"		25	75	
LN12U125	1/2"	CR-MO	5"		25	125	
LN12U150	1/2"	CR-MO	6"		25	150	

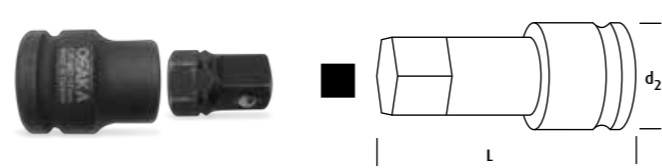

### DEĞİŞKEN UÇLU ADAPTÖR 1/2"

Model	Boyut	Malzeme	d1	d2	L	Fiyat USD
LN34-12AG	3 / 4"-1/2"	CR-MO		25	38	
LN34-12AGY	Yedek Uç	CR-MO		30	48	



### INCH LOKMA 3/4"

Model	Boyut	Malzeme	Uzunluk (mm)	d1	d2	L	Fiyat USD
LN34I1/16	3/4"	CR-MO	11 / 16	29	44	51	
LN34I3/4	3/4"	CR-MO	3 / 4	32	44	51	
LN34I13/16	3/4"	CR-MO	13 / 16	35	44	51	
LN34I7/8	3/4"	CR-MO	7 / 8	36	44	51	
LN34I15/16	3/4"	CR-MO	15 / 16	39	44	51	
LN34I1	3/4"	CR-MO	1	41	44	54	
LN34I1-1/16	3/4"	CR-MO	1-1/16	42	44	54	
LN34I1-1/8	3/4"	CR-MO	1-1/8	44	44	54	
LN34I1-3/16	3/4"	CR-MO	1-3/16	46	44	54	
LN34I1-1/4	3/4"	CR-MO	1-1/4	48	44	57	
LN34I1-5/16	3/4"	CR-MO	1-5/16	50	44	57	
LN34I1-3/8	3/4"	CR-MO	1-3/8	44	44	54	
LN34I1-1/2	3/4"	CR-MO	1-1/2	52	44	57	
LN34I1-5/8	3/4"	CR-MO	1-5/8	56	44	57	
LN34I1-13/16	3/4"	CR-MO	1-13/16	66	44	63	
LN34I2-3/16	3/4"	CR-MO	2-3/16	78	54	73	
LN34I2-3/8	3/4"	CR-MO	2-3/8	85	54	75	
LN34I2-9/16	3/4"	CR-MO	2-9/16	86	54	75	
LN34I2-3/4	3/4"	CR-MO	2-3/4	89	54	75	

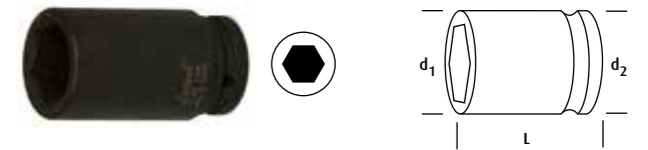

### INCH UZUN LOKMA 3/4"

Model	Boyut	Malzeme	Uzunluk (mm)	d1	d2	L	Fiyat USD
LN34ID11/16	3/4"	CR-MO	11 / 16	29	44	90	
LN34ID3/4	3/4"	CR-MO	3 / 4	32	44	90	
LN34ID13/16	3/4"	CR-MO	13 / 16	35	44	90	
LN34ID7/8	3/4"	CR-MO	7 / 8	36	44	90	
LN34ID15/16	3/4"	CR-MO	15 / 16	39	44	90	
LN34ID1	3/4"	CR-MO	1	41	44	90	
LN34ID1-1/16	3/4"	CR-MO	1-1/16	42	44	90	
LN34ID1-1/8	3/4"	CR-MO	1-1/8	44	44	90	
LN34ID1-3/16	3/4"	CR-MO	1-3/16	46	44	90	
LN34ID1-1/4	3/4"	CR-MO	1-1/4	48	44	90	
LN34ID1-5/16	3/4"	CR-MO	1-5/16	50	44	90	
LN34ID1-3/8	3/4"	CR-MO	1-3/8	44	44	90	
LN34ID1-1/2	3/4"	CR-MO	1-1/2	52	44	90	
LN34ID1-5/8	3/4"	CR-MO	1-5/8	56	44	90	
LN34ID1-13/16	3/4"	CR-MO	1-13/16	66	44	90	

### BITS ADAPTÖR 1/2" 1/4"

Model	Boyut	Malzeme	d1	d2	L	Fiyat USD
LN12-14BAD	1/2"-1/4"	CR-MO		25	75	

### MAFSAL 1/2"

Model	Boyut	Malzeme	d1	d2	L	Fiyat USD
LN12M12	1/2"-1/2"	CR-MO		25	75	



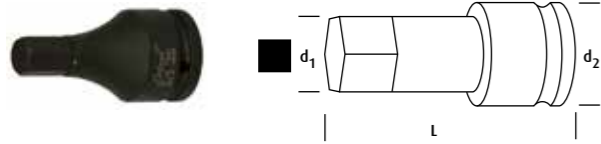

### ALLEN LOKMA 3/4"

			d1	d2	L	Fiyat USD
LN34A14	3/4"	CR-MO	14 mm	20	44	100
LN34A17	3/4"	CR-MO	17 mm	22	44	100
LN34A19	3/4"	CR-MO	19 mm	22	44	100
LN34A21	3/4"	CR-MO	21 mm	25	44	100
LN34A22	3/4"	CR-MO	22 mm	25	44	100
LN34A24	3/4"	CR-MO	24 mm	28	44	100
LN34A27	3/4"	CR-MO	27 mm	32	44	100
LN34A30	3/4"	CR-MO	30 mm	35	44	100
LN34A32	3/4"	CR-MO	32 mm	36	44	100
LN34A36	3/4"	CR-MO	36 mm	36	44	100

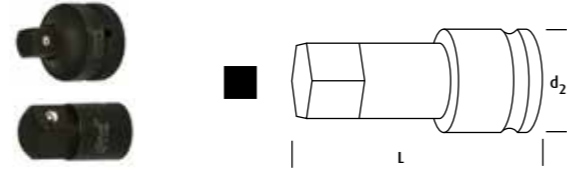

### ADAPTÖR 3/4"

			d2	L	Fiyat USD
LN34-12AD	3/4"-1/2"	CR-MO	44	58	
LN34-1AD	3/4"-1"	CR-MO	44	63	
LN1-34AD	1"-3/4"	CR-MO	54	70	

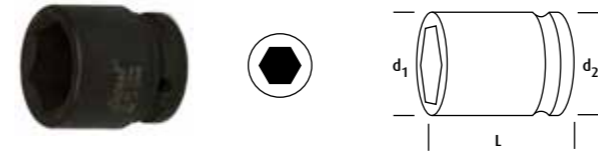

### LOKMA 1"

			d1	d2	L	Fiyat USD
LN1S21	1"	CR-MO	21 mm	39.6	54	58
LN1S22	1"	CR-MO	22 mm	39.6	54	58
LN1S23	1"	CR-MO	23 mm	40.6	54	58
LN1S24	1"	CR-MO	24 mm	41.9	54	58
LN1S25	1"	CR-MO	25 mm	43.1	54	58
LN1S26	1"	CR-MO	26 mm	43.1	54	58
LN1S27	1"	CR-MO	27 mm	45.6	54	58
LN1S28	1"	CR-MO	28 mm	47	54	58
LN1S29	1"	CR-MO	29 mm	48.1	54	60
LN1S30	1"	CR-MO	30 mm	49.4	54	60
LN1S32	1"	CR-MO	32 mm	51.9	54	61
LN1S33	1"	CR-MO	33 mm	53.6	54	61
LN1S34	1"	CR-MO	34 mm	54.4	54	61
LN1S35	1"	CR-MO	35 mm	55.7	54	61
LN1S36	1"	CR-MO	36 mm	56.9	54	65
LN1S38	1"	CR-MO	38 mm	59.4	54	65
LN1S41	1"	CR-MO	41 mm	63.1	54	65
LN1S46	1"	CR-MO	46 mm	69.4	54	74
LN1S48	1"	CR-MO	48 mm	69.4	54	74
LN1S50	1"	CR-MO	50 mm	74.4	54	74
LN1S55	1"	CR-MO	55 mm	80.7	54	85
LN1S60	1"	CR-MO	60 mm	87.1	54	89
LN1S65	1"	CR-MO	65 mm	93.2	54	93
LN1S70	1"	CR-MO	70 mm	99.4	54	98
LN1S75	1"	CR-MO	75 mm	105.6	86	100
LN1S80	1"	CR-MO	80 mm	111.9	86	100
LN1S85	1"	CR-MO	85 mm	118.5	86	102
LN1S90	1"	CR-MO	90 mm	124.4	86	107
LN1S95	1"	CR-MO	95 mm	130.8	86	107
LN1S100	1"	CR-MO	100 mm	130.8	86	107

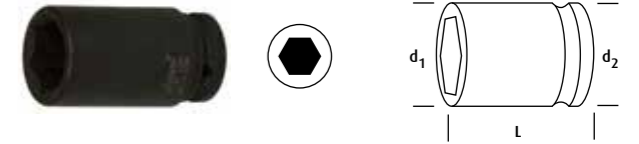

### UZUN LOKMA 1"

			d1	d2	L	Fiyat USD
LN1D22	1"	CR-MO	22 mm	39.6	54	90
LN1D23	1"	CR-MO	23 mm	40.6	54	90
LN1D24	1"	CR-MO	24 mm	41.9	54	90
LN1D25	1"	CR-MO	25 mm	43.1	54	90
LN1D26	1"	CR-MO	26 mm	43.1	54	90
LN1D27	1"	CR-MO	27 mm	45.6	54	90
LN1D28	1"	CR-MO	28 mm	47	54	90
LN1D29	1"	CR-MO	29 mm	48.1	54	90
LN1D30	1"	CR-MO	30 mm	49.4	54	90
LN1D32	1"	CR-MO	32 mm	51.9	54	90
LN1D33	1"	CR-MO	33 mm	53.6	54	90
LN1D34	1"	CR-MO	34 mm	54.4	54	90
LN1D35	1"	CR-MO	35 mm	55.7	54	90
LN1D36	1"	CR-MO	36 mm	56.9	54	90
LN1D38	1"	CR-MO	38 mm	59.4	54	90
LN1D41	1"	CR-MO	41 mm	63.1	54	90
LN1D46	1"	CR-MO	46 mm	69.4	54	100
LN1D50	1"	CR-MO	50 mm	74.4	54	100
LN1D55	1"	CR-MO	55 mm	80.7	54	100
LN1D60	1"	CR-MO	60 mm	87.1	54	120
LN1D65	1"	CR-MO	65 mm	93.2	54	120
LN1D70	1"	CR-MO	70 mm	99.4	54	125
LN1D75	1"	CR-MO	75 mm	105.6	86	125
LN1D80	1"	CR-MO	80 mm	111.9	86	125
LN1D85	1"	CR-MO	85 mm	118.5	86	125
LN1D90	1"	CR-MO	90 mm	124.4	86	135

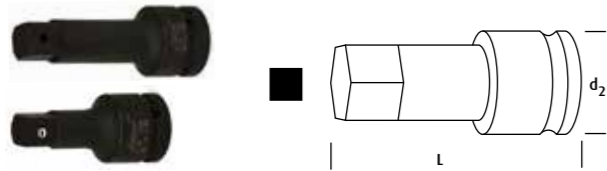

### UZATMA 3/4"

			d1	d2	L	Fiyat USD
LN34U100	3/4"	CR-MO	4"	44	100	
LN34U150	3/4"	CR-MO	6"	44	150	
LN34U200	3/4"	CR-MO	8"	44	200	
LN34U250	3/4"	CR-MO	10"	44	250	

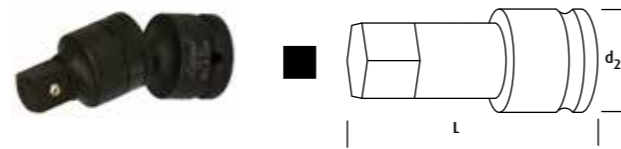

### MAFSAL 3/4"

			d2	L	Fiyat USD
LN34M34	3/4"-3/4"	CR-MO	44	105	

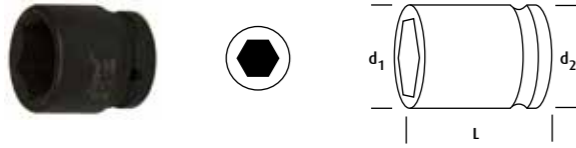

### INCH LOKMA 1"

				d1	d2	L	Fiyat USD
LN117/8	1"	CR-MO	7/8	39	54	58	
LN115/16	1"	CR-MO	15/16	41	54	58	
LN111	1"	CR-MO	1	42	54	58	
LN111-1/16	1"	CR-MO	1-1/16	46	54	58	
LN111-1/8	1"	CR-MO	1-1/8	46	54	58	
LN111-3/16	1"	CR-MO	1-3/16	49	54	62	
LN111-1/4	1"	CR-MO	1-1/4	52	54	62	
LN111-5/16	1"	CR-MO	1-5/16	54	54	62	
LN111-3/8	1"	CR-MO	1-3/8	54	54	62	
LN111-7/16	1"	CR-MO	1-7/16	56	54	65	
LN111-1/2	1"	CR-MO	1-1/2	58	54	65	
LN111-9/16	1"	CR-MO	1-9/16	60	54	65	
LN111-5/8	1"	CR-MO	1-5/8	61	54	68	
LN111-11/16	1"	CR-MO	1-11/16	66	54	68	
LN111-3/4	1"	CR-MO	1-3/4	67	54	68	
LN111-13/16	1"	CR-MO	1-13/16	68	54	72	
LN111-7/8	1"	CR-MO	1-7/8	68	54	72	
LN111-15/16	1"	CR-MO	1-15/16	72	54	72	
LN112	1"	CR-MO	2	74	54	75	
LN112-1/16	1"	CR-MO	2-1/16	75	54	75	
LN112-1/8	1"	CR-MO	2-1/8	78	54	80	
LN112-3/16	1"	CR-MO	2-3/16	80	54	83	
LN112-1/4	1"	CR-MO	2-1/4	82	54	83	
LN112-5/16	1"	CR-MO	2-5/16	84	54	83	
LN112-3/8	1"	CR-MO	2-3/8	86	54	87	
LN112-7/16	1"	CR-MO	2-7/16	88	54	87	
LN112-1/2	1"	CR-MO	2-1/2	90	54	87	
LN112-9/16	1"	CR-MO	2-9/16	92	54	90	
LN112-5/8	1"	CR-MO	2-5/8	94	54	90	
LN112-11/16	1"	CR-MO	2-11/16	95	54	93	
LN112-3/4	1"	CR-MO	2-3/4	96	54	93	
LN112-13/16	1"	CR-MO	2-13/16	100	86	95	
LN112-7/8	1"	CR-MO	2-7/8	102	86	95	
LN112-15/16	1"	CR-MO	2-15/16	104	86	95	
LN113	1"	CR-MO	3	106	86	95	
LN113-1/16	1"	CR-MO	3-1/16	106	86	95	
LN113-1/8	1"	CR-MO	3-1/8	109	86	95	
LN113-1/4	1"	CR-MO	3-1/4	113	86	100	
LN113-3/8	1"	CR-MO	3-3/8	115	86	100	
LN113-1/2	1"	CR-MO	3-1/2	122	86	100	
LN113-5/8	1"	CR-MO	3-5/8	127	86	100	
LN113-3/4	1"	CR-MO	3-3/4	130	86	105	
LN114	1"	CR-MO	4	132	86	105	

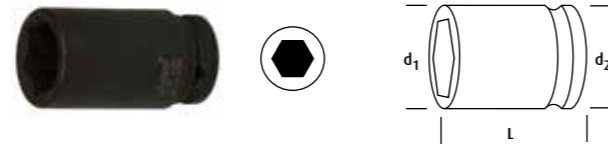

### INCH UZUN LOKMA 1"

				d1	d2	L	Fiyat USD
LN11D7/8	1"	CR-MO	7/8	39	54	90	
LN11D15/16	1"	CR-MO	15/16	41	54	90	
LN11D1	1"	CR-MO	1	42	54	90	
LN11D1-1/16	1"	CR-MO	1-1/16	46	54	90	
LN11D1-1/8	1"	CR-MO	1-1/8	46	54	90	
LN11D1-3/16	1"	CR-MO	1-3/16	49	54	90	
LN11D1-1/4	1"	CR-MO	1-1/4	52	54	90	
LN11D1-5/16	1"	CR-MO	1-5/16	54	54	90	
LN11D1-3/8	1"	CR-MO	1-3/8	54	54	90	
LN11D1-7/16	1"	CR-MO	1-7/16	56	54	90	
LN11D1-1/2	1"	CR-MO	1-1/2	58	54	95	
LN11D1-9/16	1"	CR-MO	1-9/16	60	54	95	
LN11D1-5/8	1"	CR-MO	1-5/8	61	54	95	
LN11D1-11/16	1"	CR-MO	1-11/16	66	54	95	
LN11D1-3/4	1"	CR-MO	1-3/4	67	54	95	
LN11D1-13/16	1"	CR-MO	1-13/16	68	54	95	
LN11D1-7/8	1"	CR-MO	1-7/8	68	54	95	
LN11D1-15/16	1"	CR-MO	1-15/16	72	54	100	
LN11D2	1"	CR-MO	2	74	54	100	
LN11D2-1/16	1"	CR-MO	2-1/16	75	54	100	
LN11D2-1/8	1"	CR-MO	2-1/8	78	54	100	
LN11D2-3/16	1"	CR-MO	2-3/16	80	54	105	
LN11D2-1/4	1"	CR-MO	2-1/4	82	54	105	
LN11D2-5/16	1"	CR-MO	2-5/16	84	54	105	
LN11D2-3/8	1"	CR-MO	2-3/8	86	54	110	
LN11D2-7/16	1"	CR-MO	2-7/16	88	54	110	
LN11D2-1/2	1"	CR-MO	2-1/2	90	54	110	
LN11D2-9/16	1"	CR-MO	2-9/16	92	54	115	
LN11D2-5/8	1"	CR-MO	2-5/8	94	54	115	
LN11D2-11/16	1"	CR-MO	2-11/16	95	54	120	
LN11D2-3/4	1"	CR-MO	2-3/4	96	54	120	
LN11D2-13/16	1"	CR-MO	2-13/16	100	86	135	
LN11D2-7/8	1"	CR-MO	2-7/8	102	86	135	
LN11D2-15/16	1"	CR-MO	2-15/16	104	86	135	
LN11D3	1"	CR-MO	3	106	86	135	
LN11D3-1/8	1"	CR-MO	3-1/8	109	86	135	
LN11D3-1/4	1"	CR-MO	3-1/4	113	86	135	
LN11D3-3/8	1"	CR-MO	3-3/8	115	86	140	
LN11D3-1/2	1"	CR-MO	3-1/2	122	86	140	



### KARE LOKMA 1"

				d1	d2	L	Fiyat USD
LN1K17	1"	CR-MO	17 mm	40	54	58	
LN1K19	1"	CR-MO	19 mm	42	54	58	
LN1K20	1"	CR-MO	20 mm	44	54	58	
LN1K21	1"	CR-MO	21 mm	44	54	58	

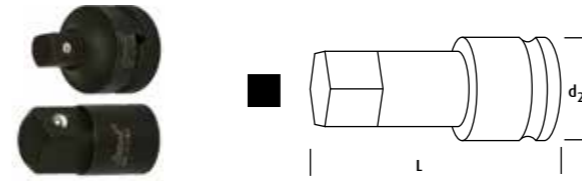

### ADAPTÖR 1"

				d1	d2	L	Fiyat USD
LN1-34AD	1"-3/4"	CR-MO			54	70	
LN1-15AD	1"-1.5"	CR-MO			54	90	
LN15-1AD	1.5" - 1"	CR-MO			86	100	

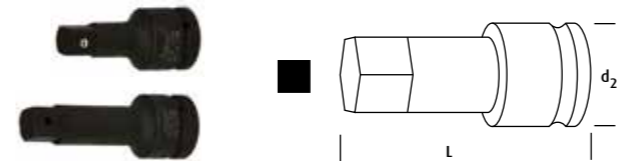

### UZATMA 1"

				d1	d2	L	Fiyat USD
LN1U100	1"	CR-MO	4"		54	100	
LN1U150	1"	CR-MO	6"		54	150	
LN1U200	1"	CR-MO	8"		54	200	
LN1U250	1"	CR-MO	10"		54	250	
LN1U300	1"	CR-MO	12"		54	300	

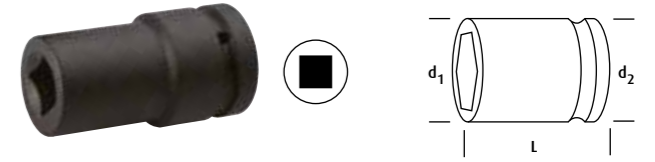

### KARE UZUN LOKMA 1"

				d1	d2	L	Fiyat USD
LN1KD17	1"	CR-MO	17 mm	40	54	100	
LN1KD19	1"	CR-MO	19 mm	42	54	100	
LN1KD20	1"	CR-MO	20 mm	44	54	100	
LN1KD21	1"	CR-MO	21 mm	44	54	100	

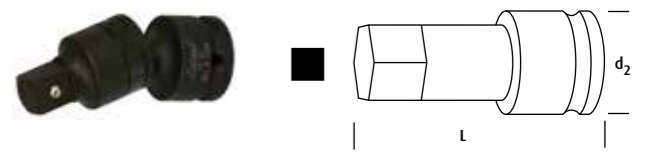

### MAFSAL 1"

				d1	d2	L	Fiyat USD
LN1M1	1"-1"	CR-MO			54	130	

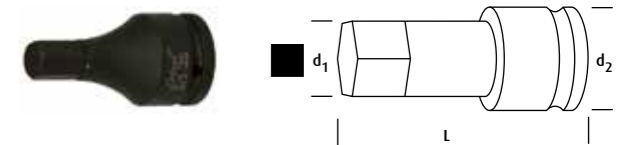

### ALLEN LOKMA 1"

				d1	d2	L	Fiyat USD
LN1A14	1"	CR-MO	14 mm	20	44	100	
LN1A17	1"	CR-MO	17 mm	20	44	100	
LN1A19	1"	CR-MO	19 mm	22	44	100	
LN1A21	1"	CR-MO	21 mm	25	44	100	
LN1A22	1"	CR-MO	22 mm	25	44	100	
LN1A24	1"	CR-MO	24 mm	28	44	100	
LN1A27	1"	CR-MO	27 mm	32	44	100	
LN1A30	1"	CR-MO	30 mm	35	44	100	
LN1A32	1"	CR-MO	32 mm	36	44	100	
LN1A36	1"	CR-MO	36 mm	36	44	100	



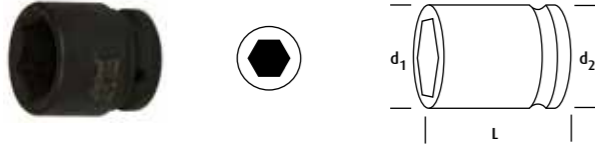

### LOKMA 1.5"

			d1	d2	L	Fiyat USD
LN15S36	1.5"	CR-MO	36 mm	62	86	78
LN15S41	1.5"	CR-MO	41 mm	68	86	80
LN15S46	1.5"	CR-MO	46 mm	74	86	84
LN15S50	1.5"	CR-MO	50 mm	79	86	84
LN15S55	1.5"	CR-MO	55 mm	86	86	90
LN15S60	1.5"	CR-MO	60 mm	92	86	90
LN15S65	1.5"	CR-MO	65 mm	97	86	95
LN15S70	1.5"	CR-MO	70 mm	103	86	100
LN15S75	1.5"	CR-MO	75 mm	108	86	105
LN15S80	1.5"	CR-MO	80 mm	118	86	110
LN15S85	1.5"	CR-MO	85 mm	122	86	110
LN15S90	1.5"	CR-MO	90 mm	128	86	112
LN15S95	1.5"	CR-MO	95 mm	135	95	112
LN15S100	1.5"	CR-MO	100 mm	140	95	115
LN15S105	1.5"	CR-MO	105 mm	146	95	120
LN15S110	1.5"	CR-MO	110 mm	153	95	124
LN15S115	1.5"	CR-MO	115 mm	160	95	128
LN15S120	1.5"	CR-MO	120 mm	166	95	132
LN15S125	1.5"	CR-MO	125 mm	173	95	136
LN15S130	1.5"	CR-MO	130 mm	180	95	140



### ÇİFT FONKSİYONLU LOKMA 1"

			d1	d2	L	Fiyat USD
LN1B3820	1"	CR-MO	38X20 mm	57	54	96
LN1B4121	1"	CR-MO	41X21 mm	58	54	100

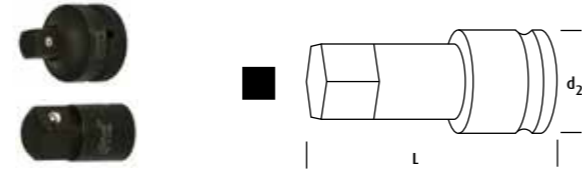

### ADAPTÖR 1.5"

			d1	d2	L	Fiyat USD
LN1-15AD	1" - 1.5"	CR-MO		54	90	
LN15-1AD	1.5" - 1"	CR-MO		86	100	





**LÜDECKE**

Lüdecke



## Ω DIN 7.2 MAX BAS -20/+100

HAVA GEÇİRGENLİĞİ 450 L/DK

ES STOPER ERKEK GÖVDE		L	D	Fiyat EU
ES 14 A	R 1/4"	22	42	27
ES 38 A	R 3/8"	22	42	27
ES 12 AB	R 1/2"	22	42	27



ES STOPER DIŞI GÖVDE		L	D	Fiyat EU
ES 14 I	R 1/4"	22	42	27
ES 38 I	R 3/8"	22	42	27
ES 12 I	R 1/2"	22	42	27



ES STOPER GÖVDE		L	D	Fiyat EU
ES 8 T	8 mm	22	42	27
ES 10 T	9 mm	22	42	27
ES 13 T	13 mm	22	42	2



ES STOPER ERKEK UÇ		L	D	Fiyat EU
ES 14 NA	R 1/4"	17	33	9
ES 38 NA	R 3/8"	19	33	9
ES 12 NA	R 1/2"	24	35	9



ES STOPER DIŞI UÇ		L	D	Fiyat EU
ES 14 NI	R 1/4"	17	33	9
ES 38 NI	R 3/8"	19	33	9
ES 12 NI	R 1/2"	24	35	9



ES STOPER HORTUM UCU		L	D	Fiyat EU
ES 8 S	8 mm	44	12	
ES 10 S	9 mm	44	12	
ES 13 S	13 mm	44	12	



## Ω DIN 5 MAX BAS -20/+100

HAVA GEÇİRGENLİĞİ 450 L/DK

ESM STOPER ERKEK GÖVDE		L	D	Fiyat EU
ESM 18 A	R 1/8"	14	37	7
ESM 14 A	R 1/4"	17	37	9



ESM STOPER DIŞI GÖVDE		L	D	Fiyat EU
ESM 18 I	R 1/8"	14	37	9
ESM 14 I	R 1/4"	17	37	9



ESM STOPER GÖVDE		L	D	Fiyat EU
ESM 6 T	6 mm	46	17	
ESM 8 T	8 mm	46	17	



ESM STOPER ERKEK UÇ		L	D	Fiyat EU
ESM 18 NA	R 1/8"	13	25	7
ESM 14 NA	R 1/4"	17	27,5	9



ESM STOPER DIŞI UÇ		L	D	Fiyat EU
ESM 18 NI	R 1/8"	13	25	9
ESM 14 NI	R 1/4"	17	26	10



ESM STOPER HORTUM UCU		L	D	Fiyat EU
ESM 6 S	6 mm	32	9	
ESM 8 S	8 mm	32	12	



ESM STOPER NETWORK		L	D	Fiyat EU
DWS 38 ES	R 3/8" 2'LI	67	26	
VWS 38 ES	R 3/8" 3'LÜ	67	26	



## Ω DIN 19 MAX BAS -20/+100

HAVA GEÇİRGENLİĞİ 8000 L/DK

ESG STOPER ERKEK GÖVDE		L	D	Fiyat EU
ESG 34 A	R 3/4"	41	95	46
ESG 10 A	R 1"	41	98	46



ESG STOPER DIŞI GÖVDE		L	D	Fiyat EU
ESG 34 I	R 3/4"	41	99	46
ESG 10 I	R 1"	41	100	46



ESG STOPER GÖVDE		L	D	Fiyat EU
ESG 19 T	19 mm	115	46	
ESG 25 T	25 mm	125	46	



ESG STOPER ERKEK UÇ		L	D	Fiyat EU
ESG 34 NA	R 3/4"	30	60	34
ESG 10 NA	R 1"	36	65	34



ESG STOPER DIŞI UÇ		L	D	Fiyat EU
ESG 34 NI	R 3/4"	32	58	34
ESG 10 NI	R 1"	41	68	34



ESG STOPER HORTUM UCU		L	D	Fiyat EU
ESG 19 S	19 mm	75	36	
ESG 25 S	25 mm	87	48	



## Ω DIN 10 MAX BAS -20/+100

HAVA GEÇİRGENLİĞİ 2600 L/DK

ESIG STOPER ERKEK GÖVDE		L	D	Fiyat EU
ESIG 14 A	R 1/4"	24	63	27
ESIG 38 A	R 3/8"	24	63	27
ESIG 12 A	R 1/2"	24	65	27



ESIG STOPER DIŞI GÖVDE		L	D	Fiyat EU
ESIG 14 I	R 1/4"	24	56	27
ESIG 38 I	R 3/8"	24	56	27
ESIG 12 I	R 1/2"	24	56	27



ESIG STOPER GÖVDE		L	D	Fiyat EU
ESIG 13 T	13 mm	24	76	27
ESIG 16 T	16 mm	24	76	27
ESIG 19 T	19 mm	24	76	27



ESIG STOPER ERKEK UÇ		L	D	Fiyat EU
ESIG 14 NAS	R 1/4"	17	40	21
ESIG 38 NAS	R 3/8"	17	40	21
ESIG 12 NAS	R 1/2"	22	45	21



ESIG STOPER DIŞI UÇ		L	D	Fiyat EU
ESIG 14 NIS	R 1/4"	19	33	21
ESIG 38 NIS	R 3/8"	19	33	21
ESIG 12 NIS	R 1/2"	24	37	21



ESIG STOPER HORTUM UCU		L	D	Fiyat EU
ESIG 13 S	13 mm	24	76	27
ESIG 16 S	16 mm	24	76	27
ESIG 19 S	19 mm	24	76	27



## Ω DIN 7.2 MAX BAS -20/+100

DÖKÜM TIRNAKARASI 42 MM

SKG TIRNAKLI HORTUM REKORU	L	D	Fiyat EU
SKG 13	1/2"	13 mm	69 63
SKG 19	3/4"	19 mm	69 63
SKG 25	1"	25 mm	70 63
SKG 32	1 1/4"	32 mm	70 63



KIG TIRNAKLI REKOR	L	D	Fiyat EU
KIG 12	1/2"	13 mm	38 63
KIG 34	3/4"	19 mm	40 63
KIG 10	1"	25 mm	40 63
KIG 54	1 1/4"	32 mm	55 63



KAG TIRNAKLI REKOR	L	D	Fiyat EU
KAG 12	1/2"	13 mm	47 63
KAG 34	3/4"	19 mm	50 63
KAG 10	1"	25 mm	47 63
KAG 54	1 1/4"	32 mm	52 63



SKSS TIRNAKLI HORTUM REKORU	L	D	Fiyat EU
SKSS 13	1/2"	13 mm	74 63
SKSS 19	3/4"	19 mm	75 63
SKSS 25	1"	25 mm	75 63



KISS TIRNAKLI REKOR	L	D	Fiyat EU
KISS 12	1/2"	13 mm	37 63
KISS 34	3/4"	19 mm	39 63
KISS 10	1"	25 mm	47 63



KASS TIRNAKLI REKOR	L	D	Fiyat EU
KASS 12	1/2"	13 mm	49 63
KASS 34	3/4"	19 mm	49 63
KASS 10	1"	25 mm	53 63



## Ω DIN 7.2 MAX BAS -20/+100

HAVA GEÇİRGENLİĞİ 1100 L/DK

MST KAMLOK HORTUM REKORU	L	D	Fiyat EU
MST 38	38 mm	77	132
MST 50	50 mm	94	140
MST 65	60 mm	105	185



MIG KAMLOK REKOR	L	D	Fiyat EU
MIG 15/42	1-1/2"	38 mm	84 66
MIG 20/50	2"	50 mm	94 79
MIG 25/65	2-1/2"	60 mm	105 81



VST KAMLOK REKOR	L	D	Fiyat EU
VST 38/35	38 mm	49.5	120
VST 50	50 mm	63	140
VST 60	60 mm	73	156



VAG KAMLOK REKOR	L	D	Fiyat EU
VAG 10/25	1"	41	76 35
VAG 54/35	1-1/4"	50	83 49.5
VAG 25/42	1-1/2"	55	77 53
VAG 20/50	2"	65	90 63



SL DÖKÜM HORTUM KELEPÇESİ	L	D	Fiyat EU
SL 29	22-29 mm	1/2"	18 63
SL 34	28-34 mm	3/4"	18 71
SL 40	32-40 mm	1"	18 81
SL 49	39-49 mm	1-1/4"	20 91
SL 60	48-60 mm	1-1/2"	24 108
SL 72	56-72 mm	2"	25 116
SL 76	60-76 mm	2-1/4"	25 127
SL 94	77-94 mm	2-1/2"	30 146







**OSA***ccess*

Aksesuarlar





## OSAKA FLAP ALÜMİNYUM OKSİT

22.55 MMX18 MM 72 ADET YÜKSEK KALİTE ZİMPARA		Fiyat
OSA-FLP115A0-120	115 mm Flap Disk A. Oxit 120 Kum	

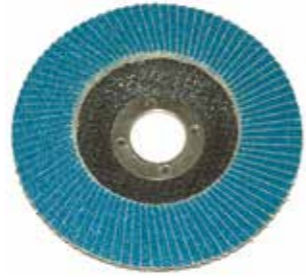

## OSAKA FLAP ZİRKONYUM

22.55 MMX18 MM 72 ADET YÜKSEK KALİTE ZİMPARA		Fiyat USD
OSA-FLP115ZR-60	115 mm Flap Disk Zirkonyum 60 Kum	
OSA-FLP115ZR-80	115 mm Flap Disk Zirkonyum 80 Kum	



## OPT-P 363 AKSESUARLARI

## OSAKA TANK ZİMPARA

		Fiyat
OSA-2251111	22.5X11 mm Delikli Cırtlı Zımpara	



## OPT-P 368 AKSESUARLARI

## OSAKA CİRTLİ ZİMPARA

22.55 MMX18 MM 72 ADET YÜKSEK KALİTE ZİMPARA		Fiyat USD
OSA-0050	50 mm Cırtlı Zımpara	

## VAKUMLU ORBİTAL ZİMPARA AKSESUARLARI



## CİRTLİ-YAPIŞMALI ZİMPARA

22.55 MMX18 MM 72 ADET YÜKSEK KALİTE ZİMPARA		Fiyat
OSA-CZ125-60	125 mm 5 Delikli Cırtlı Zımpara	
OSA-CZ125-80	125 mm 5 Delikli Cırtlı Zımpara	
OSA-CZ125-120	125 mm 5 Delikli Cırtlı Zımpara	
OSA-CZ125-150	125 mm 5 Delikli Cırtlı Zımpara	
OSA-CZ125-180	125 mm 5 Delikli Cırtlı Zımpara	
OSA-CZ150-60	150 mm 6+1 Delikli Cırtlı Zımpara 60 Kum	
OSA-CZ150-80	150 mm 6+1 Delikli Cırtlı Zımpara 80 Kum	
OSA-CZ150-100	150 mm 6+1 Delikli Cırtlı Zımpara 100 Kum	
OSA-CZ150-120	150 mm 6+1 Delikli Cırtlı Zımpara 120 Kum	
OSA-CZ150-150	150 mm 6+1 Delikli Cırtlı Zımpara 150 Kum	
OSA-CZ150-180	150 mm 6+1 Delikli Cırtlı Zımpara 180 Kum	
OSA-CZ150-220	150 mm 6+1 Delikli Cırtlı Zımpara 220 Kum	
OSA-CZ125-60	125 mm 5 Delikli Cırtlı Zımpara	
OSA-YZ125-80	125 mm 5 Delikli Yapıştırmalı Zımpara 80 Kum	
OSA-YZ125-120	125 mm 5 Delikli Yapıştırmalı Zımpara 120 Kum	
OSA-YZ125-150	125 mm 5 Delikli Yapıştırmalı Zımpara 120 Kum	
OSA-YZ150-60	150 mm 6 Delikli Yapıştırmalı Zımpara 60 Kum	
OSA-YZ150-80	150 mm 6 Delikli Yapıştırmalı Zımpara 80 Kum	
OSA-YZ150-120	150 mm 6 Delikli Yapıştırmalı Zımpara 120 Kum	
OSA-YZ150-150	150 mm 6 Delikli Yapıştırmalı Zımpara 150 Kum	

## DİP PROFİL AKSESUARLARI



## OSA EET09 12Lİ ELMAS EĞE SETİ

## TESTERE AKSESUARLARI



## YEDEK TESTERELER

		Fiyat USD
OSA-YT313	Yedek Testere	

## OPT-P 716 AKSESUARLARI



## OSAKA VİDALI ZİMPARA

		Fiyat
OSA-ZV375	37.5 mm Vidalı 80-120-180-240-320 Kum	
OSA-ZV500	50.0 mm Vidalı 80-120-180-240-320 Kum	
OSA-ZV750	75.0 mm Vidalı 80-120-180-240-320 Kum	

## OPT-P 716 AKSESUARLARI



## OSAKA GEÇMELİ ZİMPARA

		Fiyat
OSA-ZG375	37.5 mm Geçmeli 80-100-120	
OSA-ZG500	50.0 mm Geçmeli 80-100-120	
OSA-ZG750	75.0 mm Geçmeli 80-100-120	

## OPT-P 716 AKSESUARLARI



## OSAKA VİDALI SCOTCH

		Fiyat
OSA-ZS750	75 mm Vidalı SCOTCH	





## BANT ZIMPARA

		Fiyat
OSA-26060	260x60 mm Bant Zımpara	

## KALIPÇI TAŞLAMA AKSESUARLARI



## FİBER AŞINDIRICI

		Fiyat
OSA-PT157	37.5 mm Boya ve Pas Temizleyici	
OSA-PT207	50 mm Boya ve Pas Temizleyici	
OSA-PT307	75 mm Boya ve Pas Temizleyici	
OSAPT-407	100 mm Boya ve Pas Temizleyici	



## ORBİTAL ZIMPARA AKSESUARLARI

## EVA TABANLAR

		Fiyat
OSA-C 2	50 mm Cırtlı Taban	
OSA-C 3	75 mm Cırtlı Taban	
OSA-C125	125 mm Cırtlı 5 Delikli Taban	
OSA-Y125	125 mm Yapışmalı 5 Delikli Taban	
OSA-C150	150 mm Cırtlı 6 Delikli Taban	
OSA-Y150	150 mm Yapışmalı 6 Delikli Taban	

## OPT-P 716A AKSESUARLARI



## LASTİK TABANLAR

		Fiyat
OSA-V154	37.5 mm Vidalı Taban	
OSA-V204	50 mm Vidalı Taban	
OSA-V304	75 mm Vidalı Taban	
OSA-G155	37.5 mm Geçmeli Taban	
OSA-G205	50 mm Geçmeli Taban	
OSA-G305	75 mm Geçmeli Taban	

## BANT ZIMPARA AKSESUARLARI



## BANT ZIMPARA

		Fiyat
OSA33010	330x10mm Bant Zımpara 80-100-120 Kum	
OSA52020	520x20mm Bant Zımpara 80-100-120 Kum	
OSA54030	540x30mm Bant Zımpara 80-100-120 Kum	

## KALIPÇI TAŞLAMA AKSESUARLARI



## LASTİK SİLGİ

		Fiyat
OSA-KST400	100 mm Kauçuk Silgi	

## 180 MM TAŞLAMA AKSESUARLARI



## LASTİK CİRTLİ TABANLAR

		Fiyat
OSA-PT704	150 mm Cırtlı Taban M14	
OSA-PT705	180 mm Cırtlı Taban M14	

## KALIPÇI TAŞLAMA AKSESUARLARI



## POLİSAJ KEÇESİ YÜN

		Fiyat
OSA-ZS750	75 mm Yün Polısaj	

## VAKUMLU ZIMPARA AKSESUARLARI



## DELİKLİ CİRTLİ TABAN

		Fiyat
OSA-C150-54	Delikli Cırtlı Taban	

## 125 MM & 180 MM TAŞLAMA AKSESUARLARI



## EVA TABANLAR

		Fiyat
OSA-TC125	125 mm Cırtlı Taban M14	
OSA-TY150	150 mm Yapışmalı Taban M14	
OSA-TC150	150 mm Cırtlı Taban M14	

## POLİSAJ SÜNGERİ

		Fiyat
OSA-GSM14	14 mm Pasta Süngeri Beyaz	
OSA-PSM14	14 mm Polısaj Süngeri Sarı	

## OPC 65110-C AKSESUARLARI



OSA-065023	23 mm Firça	Fiyat
------------	-------------	-------



OSA 065801	23 mm Lastik Disk	Fiyat
------------	-------------------	-------



OSA 065011	11 mm Firça	
------------	-------------	--



OSA 065701	11 mm Fiber Disk	
------------	------------------	--



OSA 065111	11 mm Sert Firça	
------------	------------------	--



OSA 065903	11 mm Adaptör	
------------	---------------	--



OSA 065904	23 mm Adaptör	
------------	---------------	--



OSA 065123	23 mm Sert Firça	
------------	------------------	--



OSA 065901	11 mm Scotch Adaptörü	
------------	-----------------------	--



OSA 065902	23 mm Scotch Adaptörü	
------------	-----------------------	--

## KESKİ MURÇ VE RASPALAR

### OPT-P 150-6K AKSESUARLARI



OSA -KS2	4'lü Yedek Keski Seti 125 mm	Fiyat
----------	------------------------------	-------

### OPT-P 150-6K AKSESUARLARI



OSA -KS3	5'li Yedek Keski Seti 125 mm	Fiyat
----------	------------------------------	-------

### OPT-P 190-4K AKSESUARLARI



OSA -KS4	5'li Yedek Keski Seti 175 mm	
----------	------------------------------	--



OSA-KS11-11	Yedek Murç OPT-P 11 İÇİN	
OSA-KS12-11	Yedek Keski OPT-P 11 İÇİN	
OSA-KS11	Yedek Murç OPT-P 12-15 İÇİN	
OSA-KS12	Yedek Keski OPT-P12-15 İÇİN	



AH16	OPT-150-6K için Yay	
AH17	OPT-P 190-4K için Yay	

### OPT-P 281 AKSESUARLARI



OSA-R1281	3x180 mm Raspa Çivisi	
-----------	-----------------------	--



OSA-R10	Raspa OPT-P 10 İÇİN	
---------	---------------------	--



OSA-R20	Raspa OPT-P 20 İÇİN	
---------	---------------------	--



## KESKİ MURÇ KİLİDİ

OSA-LKS5	Otomatik Keski Kilidi	Fiyat
----------	-----------------------	-------



## FİTİL KESME YEDEKLERİ - OPT 216 İÇİN



		Fiyat
OSA-FK02	Yedek Fitil Kesme	



OSA-FK03	Yedek Fitil Kesme	
----------	-------------------	--



OSA-FK07	Yedek Fitil Kesme	
----------	-------------------	--



OSA-FK04	Yedek Fitil Kesme Uzunluk 9 cm	
----------	--------------------------------	--



OSA-FK01	Yedek Fitil Kesme	
----------	-------------------	--



## KILAVUZ ÇEKME ADAPTÖR

		Fiyat
OSA TCS2-TCS1	Adaptör	



## KILAVUZ ÇEKME YEDEK PENSLER

3-12		Fiyat
OSA KTP2/TCS1	Yedek Pens	
OSA KTP3/TCS1	Yedek Pens	
OSA KTP4/TCS1	Yedek Pens	
OSA KTP5/TCS1	Yedek Pens	
OSA KTP6/TCS1	Yedek Pens	
OSA KTP8/TCS1	Yedek Pens	
OSA KTP10/TCS1	Yedek Pens	
OSA KTP12/TCS1	Yedek Pens	

3-16 / 4-22		Fiyat
OSA KTP4/TCS2	Yedek Pens	
OSA KTP5/TCS2	Yedek Pens	
OSA KTP6/TCS2	Yedek Pens	
OSA KTP8/TCS2	Yedek Pens	
OSA KTP10/TCS2	Yedek Pens	
OSA KTP12/TCS2	Yedek Pens	
OSA KTP 14/TCS2	Yedek Pens	
OSA KTP16/TCS2	Yedek Pens	
OSA KTP18/TCS2	Yedek Pens	
OSA KTP20/TCS2	Yedek Pens	
OSA KTP22/TCS2	Yedek Pens	



## MİNİ GRES POMPASI

		Fiyat
OSA-MG P1035	Mini Gres Pompası	



## OYNAR BAŞLI FITING

		Fiyat
OSA-1012	Dynar Başlıklı Fiting	



## REGÜLATÖR

		Fiyat
OSA-1010	Mini Regülatör	



## SU TUTUCU

		Fiyat
OSA-1026	Mini Su Tutucu	



## YAĞLAYICI

		Fiyat
OSA-1025	Mini Yağlayıcı	



## REGÜLATÖR SAATLİ

		Fiyat
OSA-1013	Saatli Mini Regülatör	



## OPT-P 619 AKSESUARLARI



### YEDEK PUNTA FREZESİ

		Fiyat
OSA-619	8.00 mm Punta Çürütme Ucu ( Karbür )	

## KALIPÇI TAŞLAMA AKSESUARLARI



### YEDEK PENS

		Fiyat
OSA-P3	3 mm Pens	
OSA-P6	6 mm Pens	



Paket içeriği 2 Adet

### CIRTLI POLİSAJ SÜNGERLERİ

		Fiyat
OSA-SNG150S	150 mm Yumuşak	
OSA-SNG180S	180 mm Yumuşak	
OSA-SNG200S	200 mm Yumuşak	



Paket içeriği 2 Adet

### CIRTLI POLİSAJ SÜNGERLERİ

		Fiyat
OSA-SNG150H	150 mm Sert	
OSA-SNG180H	180 mm Sert	
OSA-SNG200H	200 mm Sert	



### YEDEK ELMAS UÇ

		Fiyat
OSA-Y940	Yedek Elmas Ucu OPT-P 940 İÇİN	



### OPT-P 5050 SAPLAMA

		Fiyat
OSA-5050 3	Yedek Saplama M3	
OSA-5050 4	Yedek Saplama M4	
OSA-5050 5	Yedek Saplama M5	
OSA-5050 6	Yedek Saplama M6	
OSA-5050 8	Yedek Saplama M8	
OSA-5050 10	Yedek Saplama M10	
OSA-5050 12	Yedek Saplama M12	



### CIRTLI POLİSAJ SÜNGERLERİ

		Fiyat
OSA-PLS50	180 mm İpli Yün Polijaj Pedi	
OSA-PLS70	200 mm İpli Yün Polijaj Pedi	



### CIRTLI POLİSAJ PEDİ

		Fiyat
OSA-PLS125	125 mm Yün Polijaj Pedi	
OSA-PLS150	150 mm Yün Polijaj Pedi	
OSA-PLS10	180 mm Yün Polijaj Pedi	
OSA-PLS30	200 mm Yün Polijaj Pedi	



### AVUÇ TAŞLAMA SOMUN KİLİDİ

		Fiyat
OSA06011	M14 Çabuk Değişirme Adaptörü	



### YEDEK AĞIZLAR

		Fiyat
OSA-FD6	Plastik Kesici Yedek Ucu - OPT 1007 için	
OSA-PC2	Kelepçe Sıkma Yedek Ucu 10,7 mm - OPT 1008-1009 için	
OSA-PC4	Kelepçe Sıkma Yedek Ucu 13 mm - OPT 1008-1009 için	
OSA-AR7WP	Kablo Pabucu Sıkma Yedek Ucu 2 mm - 5,5 mm - OPT 1008 için	





**OSA***fix*

Perçinler



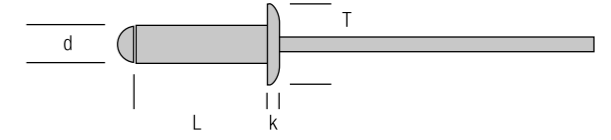
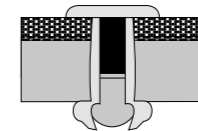
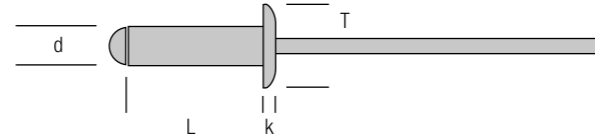
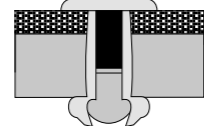

### ÇELİK-ÇELİK MERCİMEK KAFA POP PERÇİN

d	L	T	K				Paket	Ağırlık	KOD	1000 Adet Fiyatı
mm	mm	mm	mm	mm	N	N	Adet	Kg		USD
3.2	14.0	6.5	0.80	9.0-11.0	1100	1300	1000	1.92	OSF-CPP 3214	
4.0	6.0	8.0	1.0	2.0-4.0	1800	2500	1000	2.45	OSF-CPP 4006	
	8.0			1000			2.45	OSF-CPP 4008		
	10.0			1000			2.47	OSF-CPP 4010		
	12.0			1000			2.69	OSF-CPP 4012		
	14.0			1000			3.01	OSF-CPP 4014		
	16.0			1000			2.22	OSF-CPP 4016		
	18.0			500			1.30	OSF-CPP 4018		
	20.0			500			1.90	OSF-CPP 4020		
4.8	8.0	9.5	1.1	1.0-3.0	3000	4000	500	1.78	OSF-CPP 4808	
	10.0			500			1.91	OSF-CPP 4810		
	12.0			500			2.14	OSF-CPP 4812		
	14.0			500			2.19	OSF-CPP 4814		
	16.0			500			2.22	OSF-CPP 4816		
6.0	12.0	32 mm	32 mm	4.0-7.0	3500	5700	500	2.05	OSF-CPP 6012	
	14.0			500			2.20	OSF-CPP 6014		
6.4	12.0	13.4	1.8	4.0-7.0	4000	6200	250	2.14	OSF-CPP 6412	
	14.0			250			2.37	OSF-CPP 6414		
	16.0			250			2.41	OSF-CPP 6416		
	18.0			250			2.72	OSF-CPP 6418		
	20.0			250			2.94	OSF-CPP 6420		
	25.0			250			3.04	OSF-CPP 6425		
	30.0			250			3.45	OSF-CPP 6430		

### ÇELİK-ÇELİK CUPLOCK POP PERÇİN

d	L	T	K				Paket	Ağırlık	KOD	1000 Adet Fiyatı
mm	mm	mm	mm	mm	N	N	Adet	Kg		USD
3.2	10.5	6.5	0.80	5.0-7.0	4200	6500	1000	1.95	OSF-CUP 4810	
	14.5			1000			2.20	OSF-CUP 4814		
6.4	14.5			7.0-10.0	6700	8400	1000	2.70	OSF-CUP 6414	
	20.5			1000			3.20	OSF-CUP 6420		

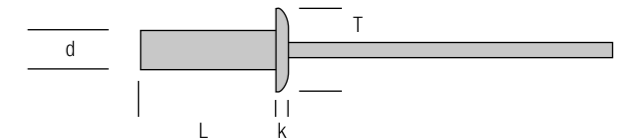
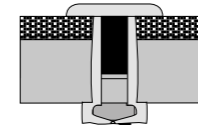

### ALÜMİNYUM-ÇELİK SIZDIRMAZ PERÇİN

d	L	T	K				Paket	Ağırlık	KOD	1000 Adet Fiyatı
mm	mm	mm	mm	mm	N	N	Adet	Kg		USD
4.8	6.0			1.0-3.0			1000		OSF-KPA 4806	
	8.0			1000				OSF-KPA 4808		
	10.0			1000				OSF-KPA 4810		
	12.0			1000				OSF-KPA 4812		



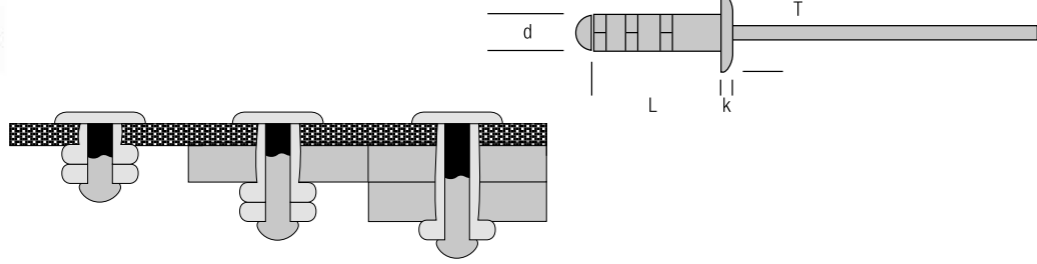

MULTİ GRİP TİP POP PERÇİN										
d	L	T	K				Paket	Ağırlık	KOD	1000 Adet Fiyatı
mm	mm	mm	mm	mm	N	N	Adet	Kg		USD
3.2	9.0	6.4	0.80	1.0-3.0	1150	1300	1000	1.33	OSF-MG 3209	
	12.0			1000			1.45	OSF-MG 3212		
	14.0			1000			1.87	OSF-MG 3214		
4.0	11.0	8.0	1.0	7.0-9.0	1800	2500	1000	1.75	OSF-MG 4011	
	13.0			1000			1.92	OSF-MG 4013		
4.8	10.0	9.5	1.20	11.0-13.0	2800	4000	1000	2.03	OSF-MG 4810	
	11.0			1000			2.45	OSF-MG 4811		
	14.0			1000			2.47	OSF-MG 4814		
	17.0			1000			2.69	OSF-MG 4817		

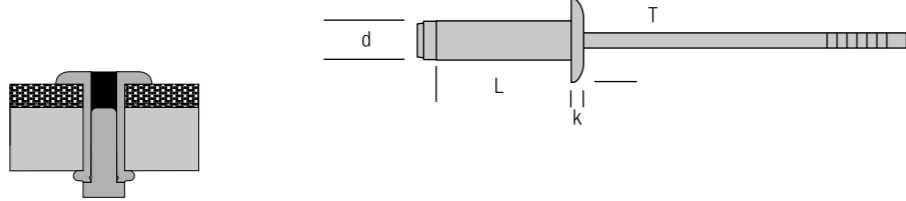

LOCK TİP POP PERÇİN										
d	L	T	K				Paket	Ağırlık	KOD	1000 Adet Fiyatı
mm	mm	mm	mm	mm	N	N	Adet	Kg		USD
4.8	11.5	9.8	1.4	1.0-6.0	4415	3826	500	1.78	OSF-LCK 48115	
	14.0			500			1.91	OSF-LCK 48140		
6.4	10.5	8.0	1.0	1.0-5.0	1800	2500	250		OSF-LCK 64105	
	12.5			250				OSF-LCK 64125		
	14.5			250				OSF-LCK 64145		
	16.5			250				OSF-LCK 64165		
	20.5			250				OSF-LCK 64205		

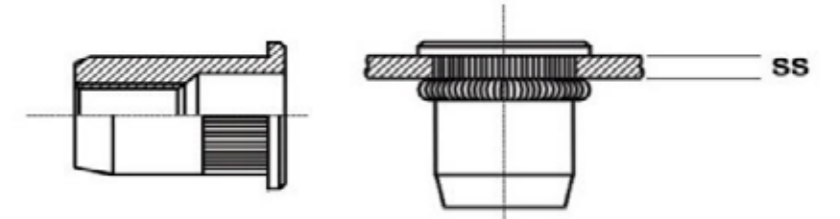

ÇELİK SOMUNLU PERÇİN FLANŞLI YUVARLAK					
Ölçü	SS	Delik Çapı	Paket	KOD	1000 Adet Fiyatı
mm	N	N	Adet		USD
3.0	0.5-2.0	5.0	500	OSF YFS3	
4.0	0.5-2.5	6.0	500	OSF YFS4	
5.0	0.5-3.0	7.0	500	OSF YFS5	
6.0	0.5-3.0	9.0	250	OSF YFS6	
8.0	0.5-3.5	11.0	250	OSF YFS8	
10.0	1.0-3.5	13.0	250	OSF YFS10	
12.0	1.0-4.0	16.0	250	OSF YFS12	

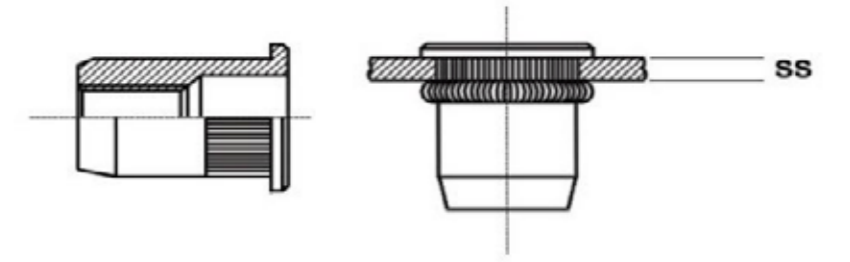

ÇELİK SOMUNLU PERÇİN FLANŞSIZ (SIFIR) YUVARLAK					
Ölçü	SS	Delik Çapı	Paket	KOD	1000 Adet Fiyatı
mm	N	N	Adet		USD
3.0	0.5-2.0	5.0	500	OSF YSS3	
4.0	0.5-2.5	6.0	500	OSF YSS4	
5.0	0.5-3.0	7.0	500	OSF YSS5	
6.0	0.5-3.0	9.0	250	OSF YSS6	
8.0	0.5-3.5	11.0	250	OSF YSS8	
10.0	1.0-3.5	13.0	250	OSF YSS10	
12.0	1.0-4.0	16.0	250	OSF YSS12	

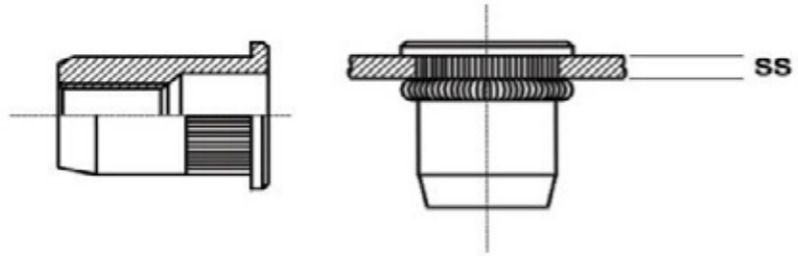

### ÇELİK SOMUNLU PERÇİN FLANŞLI ALTI KÖŞE

Ölçü mm	SS N	Delik Çapı N	Paket Adet	KOD	1000 Adet Fiyatı USD
3.0	0.5-2.0	5.0	500	OSF AFS3	
4.0	0.5-2.5	6.0	500	OSF AFS4	
5.0	0.5-3.0	7.0	500	OSF AFS5	
6.0	0.5-3.0	9.0	250	OSF AFS6	
8.0	0.5-3.5	11.0	250	OSF AFS8	
10.0	1.0-3.5	13.0	250	OSF AFS10	
12.0	1.0-4.0	16.0	250	OSF AFS12	

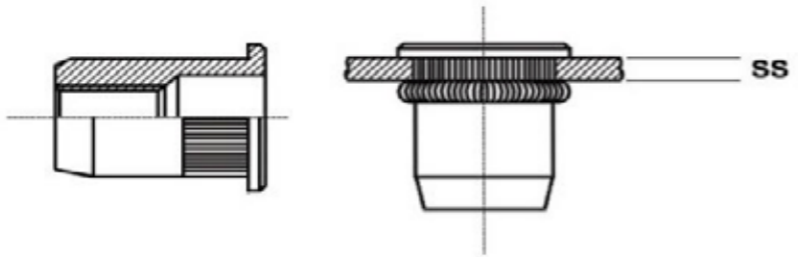

### ÇELİK SOMUNLU PERÇİN FLANŞLI ALTI KÖŞE

Ölçü mm	SS N	Delik Çapı N	Paket Adet	KOD	1000 Adet Fiyatı USD
3.0	0.5-2.0	5.0	500	OSF ASS3	
4.0	0.5-2.5	6.0	500	OSF ASS4	
5.0	0.5-3.0	7.0	500	OSF ASS5	
6.0	0.5-3.0	9.0	250	OSF ASS6	
8.0	0.5-3.5	11.0	250	OSF ASS8	
10.0	1.0-3.5	13.0	250	OSF ASS10	
12.0	1.0-4.0	16.0	250	OSF ASS12	

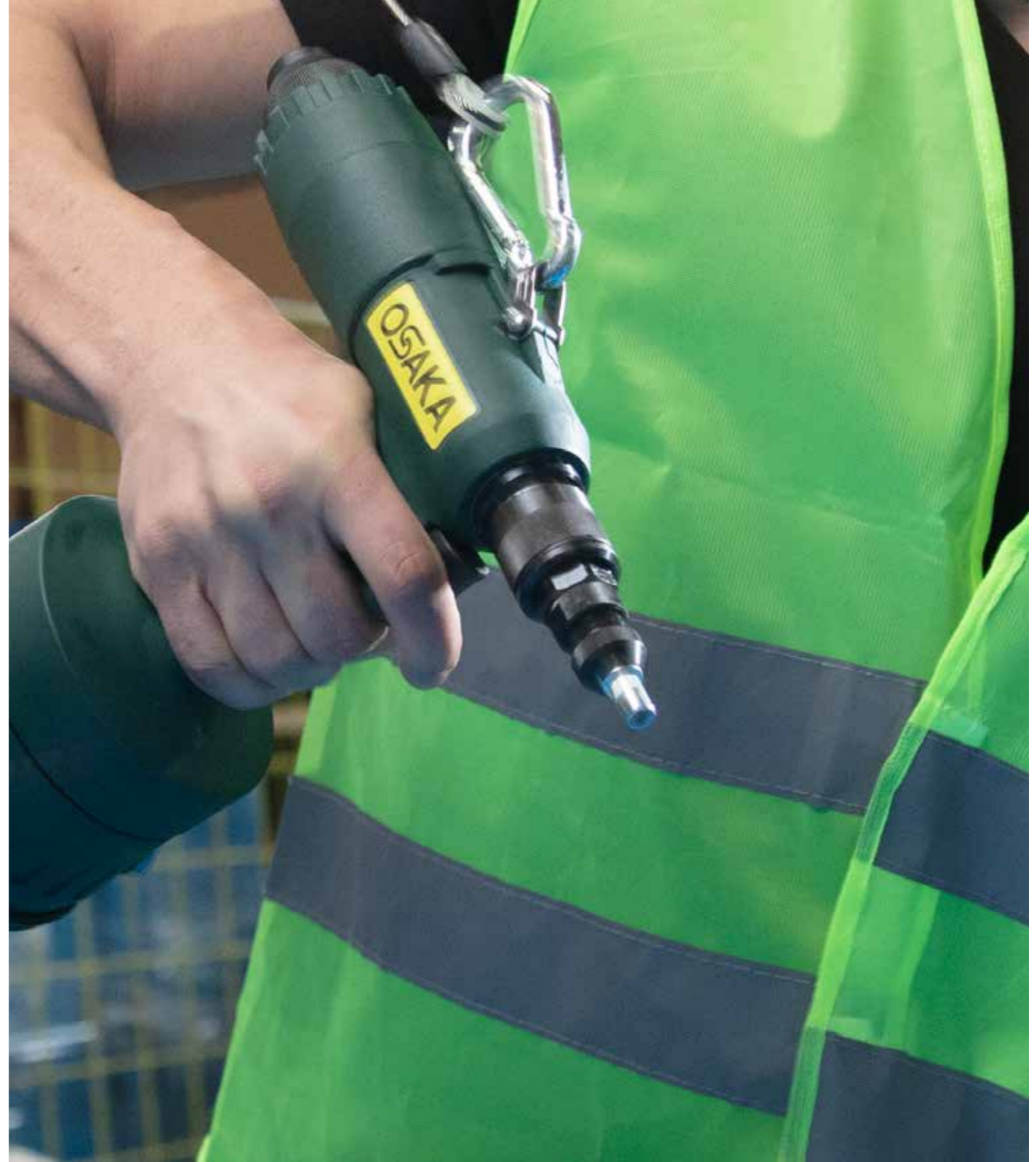





## SDS PLUS MATKAP UÇLARI

Çap	Kullanım Boyu	Komple Boy	Fiyat EU
5	50	110	
5	100	160	
6	50	110	
6	100	160	
6	150	200	
6	200	250	
7	50	110	
7	100	160	
7	150	210	
8	50	110	
8	100	160	
8	150	210	
8	200	260	
8	250	310	
8	400	450	
9	100	160	
9	150	210	
10	50	110	
10	100	160	
10	150	210	
10	200	260	
10	250	310	
10	400	450	
11	100	160	
11	150	200	
11	200	260	
12	100	160	
12	150	210	
12	200	260	
12	250	300	
12	400	450	
13	100	150	
13	200	250	
13	250	300	
14	100	150	
14	150	200	
14	200	250	
14	250	300	
14	400	460	
14	550	600	
15	100	150	
16	100	150	
16	150	200	
16	200	250	
16	250	300	
16	400	450	
16	550	600	
18	150	200	
18	200	250	
18	250	300	
18	400	450	
18	550	600	
20	150	200	
20	250	300	
20	400	450	
20	550	600	
22	200	250	
22	400	450	
22	550	600	
24	200	250	
24	400	450	
25	400	450	
26	400	450	



## SDS PLUS KESKİ-MURÇ

		Fiyat EU
SDS PLUS	Mandren Adaptör	
SDS PLUS	Murç 250 mm	
SDS PLUS	Keski 250 mm	
SDS PLUS	Eğri Geniş Keski	



## SDS MAX MATKAP UÇLARI

Çap	Kullanım Boyu	Komple Boy	Fiyat EU
12	200	340	
12	400	540	
14	200	340	
14	400	540	
16	200	340	
16	400	540	
18	200	340	
18	400	540	
20	200	320	
20	400	520	
22	200	320	
22	400	520	
22	800	920	
24	200	320	
24	400	520	
25	200	320	
25	400	520	
25	800	920	
26	200	340	
26	400	520	
28	250	370	
28	450	570	
30	250	370	
30	450	570	
32	250	370	
32	450	570	
32	800	920	
35	250	370	
35	450	570	
38	250	370	
38	450	570	
40	250	370	
40	800	920	
45	450	570	
50	450	570	



## SDS ÇOK KANALLI MATKAP UÇLARI

Çap	Kullanım Boyu	Komple Boy	Fiyat EU
12	200	330	
14	250	380	
16	250	380	
16	400	530	
18	250	380	
20	250	380	
20	400	530	
22	200	330	
22	400	530	
24	200	330	
24	400	530	
25	200	330	
25	400	530	
28	250	380	
28	400	530	
28	550	630	
30	400	530	
32	250	380	
32	400	530	
35	400	530	
38	400	530	



## SERAMİK VE TAŞ DELME SETİ

ELMAS GRANİT DELME PANÇI	5 mm
ELMAS GRANİT DELME PANÇI	6 mm
ELMAS GRANİT DELME PANÇI	8 mm
ELMAS GRANİT DELME PANÇI	10 mm
MERKEZLEME GÖNYESİ	
SU BAĞLANTI VANASI	
SU POMPASI	



## SDS MAX. KESKİ VE MURÇLAR

	Boy	Fiyat EU
SDS MAX MURÇ	280	
SDS MAX MURÇ	400	
SDS MAX MURÇ	600	
SDS MAX KESKİ	400	
SDS MAX KESKİ	600	
SDS MAX GENİŞ KESKİ	80x300	
SDS MAX GENİŞ KESKİ	50x400	

LPG KOMBİNE CIRCİR ANAHTAR



	Fiyat USD
8 mm	
9 mm	
10 mm	
11 mm	
12 mm	
13 mm	
14 mm	
15 mm	
16 mm	
17 mm	
18 mm	
19 mm	
22 mm	
1 / 2 Adaptör	

LFPG KOMBİNE MAFSALLI CIRCİR ANAHTAR



	Fiyat USD
8 mm	
9 mm	
10 mm	
11 mm	
12 mm	
13 mm	
14 mm	
15 mm	
16 mm	
17 mm	
18 mm	
19 mm	
22 mm	

PG 10 F KOMBİNE ANAHTAR



Mafsallı-Circirli	
Anahtarlar:	8-10-12-13-17-19
Adaptörler:	1/4-3/8-1/2

PM 2480 TORNAVİDA



Uzunluk:	190 mm
Soket Karesi:	1/4"
Vida Çapı:	6 mm
Max. Tork:	1.30 kg/m
Boşta Devir:	1.800 Rpm
Hortum Çapı:	9.50 mm
Hava Giriş Nipeli:	1/4"
Hava Tüketimi:	170 lt/dak
Çalışma Basıncı:	90 psi (6.2 atü)
Ağırlık:	1.10 kg

GOLD 2400 SERAMİK KESME



Kesme Uzunluğu:	460 mm
Kesme Kalınlığı:	14 mm

GOLD 2400 SERAMİK KESME



Kesme Uzunluğu:	860 mm
Kesme Kalınlığı:	14 mm



CRM 8102 SERAMİK KESME



Kesme Uzunluğu:	630 mm
Kesme Kalınlığı:	10 mm
Bıçak:	16x6x3 mm



Karaca Makina Hırd. San. ve Tic. A.Ş.	0212 245 24 67	GÜNEŞLİ / BAĞCILAR
Uzman Havalı Teknik Hüseyin Ergun	0212 252 34 77	İSTANBUL - KARAKÖY
Yuva Havalı Servis	0212 369 07 08	İSTANBUL - PERPA
Aygün Havalı Servis, Çetin Aygün	0212 253 63 46	İSTANBUL - KARAKÖY
Gündoğdu Teknik Servis, Şerif Gündoğdu	0537 858 25 27	İSTANBUL - KARAKÖY
Ertekin Durkan	0212 526 36 57	VEFA - EMİNÖNÜ
Metin Teknik Pnomatik	0216 392 67 03	İSTANBUL - TUZLA
Hava Teknik, Mehmet Koşmaz	0312 351 20 80	ANKARA - SİTELER
Gelişim Makina San. Ltd	0312 385 90 98	ANKARA - OSTİM
Tezcan Bobinaj	0312 310 28 17	ANKARA - OSTİM
Uzman Makina El.Alt. San.	0312 395 21 07	ANKARA - OSTİM
Ankara Çözüm Elk. Ltd	0312 385 08 44	ANKARA - OSTİM
Can Otomotiv, Orhan Can	0532 525 56 74	KOCAELİ
Seyhan Bobinaj	0322 351 06 69	ADANA
Ömser Teknik Destek, Murat Yılmaz ve Ortağı	0322 438 92 22	ADANA - SEYHAN
Çengel Pnomatik, Ali Çengel	0264 275 96 94	ADAPAZARI
Eriş Bobinaj, Muammer Eriş	0242 344 47 12	ANTALYA
Gamze Havalı Teknik	0224 256 84 50	BURSA
Özteknel Havalı Servis	0224 712 35 25	BURSA - İNEGÖL
Kule Makina	0542 275 79 52	ÇORUM
Orsel Bobinaj Ekrem Örs	0258 262 06 66	DENİZLİ
Berke Makina	0380 524 8383	DÜZCE
Erdemir Teknik Servis, Garip Erdemir	0536 682 58 97	ESKİŞEHİR
Karakuzular Bobinaj Yener Karakuzular	0533 744 65 67 / 0342 230 82 54	GAZİANTEP
Bal Bobinaj, Ahmet Bal	0326 221 57 96	HATAY - ANTAKYA
Doğru Basınçlı Hava Sisteml	0232-433 14 47	İZMİR
Havasis End. San. Tic. Ltd	0232 459 80 02	İZMİR
Sefer Basınçlı Sist. Üzeyir Çilenti	0532 158 09 84	İZMİR
Elzem Havalı Teknik, Hamdi İşyar	0352 330 33 44	KAYSERİ
Ömeroğlu Hırd. San. Tic. Ltd. Şti	0332 248 88 12	KONYA
Büyük Hidrolik İbrahim Fincan	0344 236 16 60	KAHRAMANMARAŞ
Esen Teknik	0324 336 03 40	MERSİN
Uğur Ticaret, U. Nejat Çakman	0362 238 25 74	SAMSUN
Aksa Bobinaj, Murat Şahin / Mustafa Akpınar	0362 238 88 38	SAMSUN
Saran Bobinaj	0462 325 45 64	TRABZON
Magnum-Fs.	+359877501055	PLOVDİV - BULGARİSTAN
Azer Türk Makina, İsmail Guliyev	+994 552550584	BAKÜ - AZERBAIJAN

METRİK CİVATALARDA ALTI KÖŞE Kafa Ölçüleri											
Civata Kalitesi			3.6	4.6	4.8	5.6	5.8	6.8	8.8	10.9	12.9
			Torque (Nm)	Torque (Nm)	Torque (Nm)	Torque (Nm)	Torque (Nm)	Torque (Nm)	Torque (Nm)	Torque (Nm)	Torque (Nm)
M4	3	7	0.85	1,1	1,4	1,5	1,9	2,3	2,9	4,1	4,9
M5	4	9	1,7	2,2	2,8	3,0	3,7	4,5	6,0	8,5	10
M6	5	10	2,9	3,9	4,8	5,1	6,4	7,7	10	14	17
M8	6	13	7a	9,3	12	12	16	19	25	35	41
M10	8	17	14	19	23	25	31	37	49	69	83
M12	10	19	24	32	40	43	54	65	86	120	145
M14	12	22	39	51	64	68	86	105	135	190	230
M16	14	24	59	79	98	105	130	155	210	295	355
M18	14	27	81	110	135	145	180	215	290	405	485
M20	17	30	115	155	190	205	255	305	410	580	690
M22	17	32	155	205	260	275	345	415	550	780	930
M24	19	36	265	265	330	350	440	530	710	1000	1200
M27	19	41	295	390	490	520	650	780	1050	1500	1800
M30	22	46	395	530	660	710	880	1050	1450	2000	2400
M33	24	50	540	720	900	960	1200	1450	1900	2700	3250
M36	27	55	690	920	1150	1250	1550	1850	2450	3450	4150
M39	27	60	920	1200	1500	1600	2000	2400	3200	4500	5400
M42	32	65	1100	1500	1850	1950	2450	2950	3950	5500	6650
M45	32	70	1400	1850	2300	2450	3100	3700	4950	6950	8350
M48	36	75	1700	2250	2800	300	3750	4450	5950	8400	10100
M52	36	80	2150	2900	3600	3850	4800	5750	7650	10800	12900
M56	-	85	2700	3600	4500	4800	5950	7150	9550	13400	16100
M60	-	90	3350	4450	5500	5950	7400	8900	11900	16700	20000
M64	-	95	4000	5350	6700	7150	8950	10700	14300	20100	24100
M68	-	100	4850	6500	8100	8650	10800	13000	17300	24300	29100

## ROCKING DOG

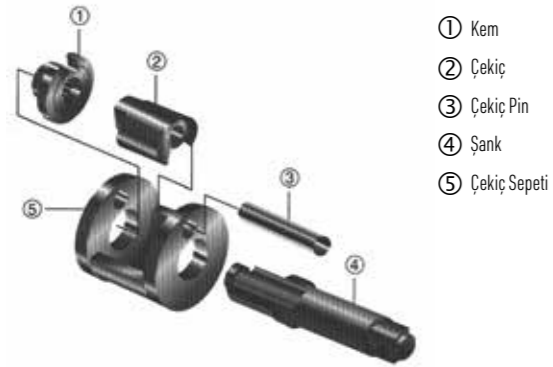

- ① Kem
- ② Çekiç
- ③ Çekiç Pin
- ④ Şank
- ⑤ Çekiç Sepeti

## PIN CLUTCH

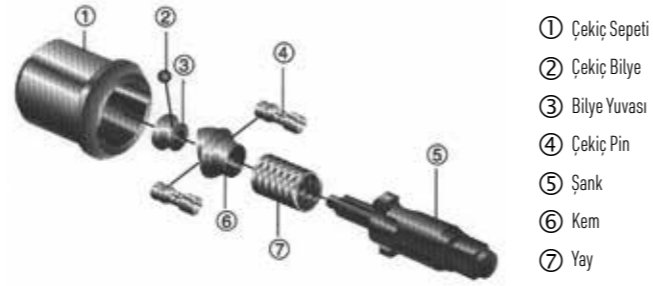

- ① Çekiç Sepeti
- ② Çekiç Bilye
- ③ Bilye Yuvası
- ④ Çekiç Pin
- ⑤ Şank
- ⑥ Kem
- ⑦ Yay

## TWIN HAMMER

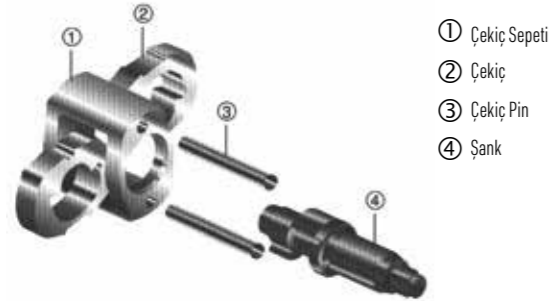

- ① Çekiç Sepeti
- ② Çekiç
- ③ Çekiç Pin
- ④ Şank

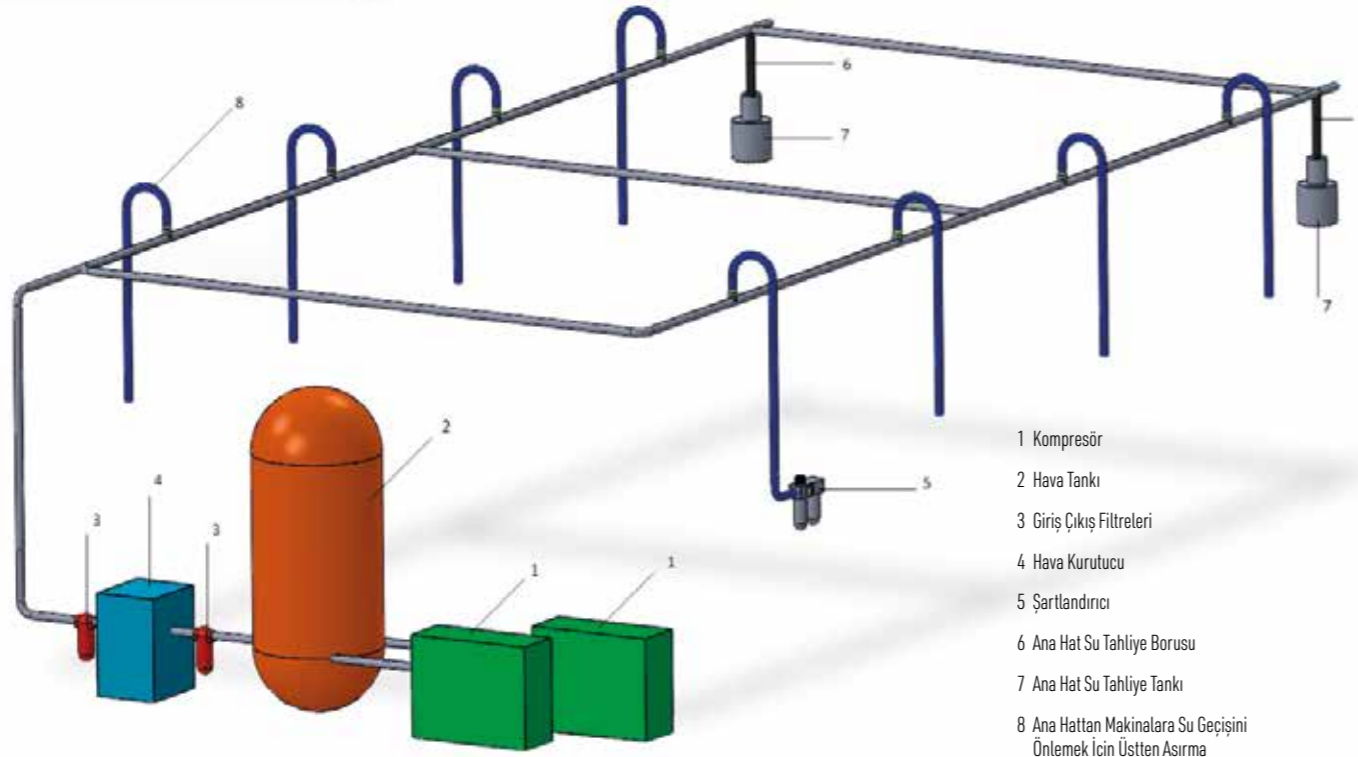

- 1 Kompresör
- 2 Hava Tankı
- 3 Giriş Çıkış Filtreleri
- 4 Hava Kurutucu
- 5 Şartlandırıcı
- 6 Ana Hat Su Tahliye Borusu
- 7 Ana Hat Su Tahliye Tankı
- 8 Ana Hattan Makinalara Su Geçişini Önlemek İçin Üstten Aşırma

## HAVA HATLARINDA BORU SEÇİMİ

Boru hatları yeraltından ya da tavandan yapılabilir. Ancak yer altından olan sistemlerde yoğunlaşan suyu almak için özel tedbirler gerekmektedir. Tavandan yapılan boru hatları kompresör den ileri doğru % 1 eğim verilerek tesis edilmeli. Borunun sarkmasına izin verilmemelidir. Bunun için galvaniz boru en kolay seçenektir. Dönüşlerde mümkün olduğunca açık dirsek kullanılmalı, hat dönerek kendi ucuna bağlamalı ve kompresöre en uzak köşede çok uzun hatlarda aralarda biriken suyu boşaltacak otomatik tahliye veya musluklu tanklar kullanılmalı. Kompresöre boru seçerken 15 metreden kısa bransmanlarda 15m/sn mertebesinde yüksek hızlarda müsaade edilebilir. Örnek 265 lt/sn bir kompresör için (265X60dk= 1590 lt/dk) 80 mm çapında boru gerekir. Ana hatlarda azami debi seviyeleri Tablo 1'de, bransmanlarda ve hortumlarda azami debi seviyesi Tablo 3'te gösterilmiştir.

Cetop standartlarına göre kullanılacak debi birimi lt/sn dir. Ancak ülkemizde lt/dk daha yaygın kullanıldığından tablolar lt/dk olarak düzenlenmiştir.

Nom. Delik mm	Hakiki Delik mm	Boru Ölçüsü Inch	Debi lt/dk
6	6	1/4"	60
8	9	5/16"	180
10	12	3/8"	300
15	16	1/2"	600
20	22	3/4"	1,000
25	27	1"	1,500
32	36	1.1/4"	3,000
40	42	1.1/2"	3900
50	53	2"	6,000
65	69	2.1/2"	10800
80	81	3"	14,400
100	105	4"	24,600
125	130	5"	36600
150	155	6"	54,000

Tablo 1

Basınç bar	6 (1/4")	8 5/16"	10 3/8"	15 5/8"	20 3/4"	25 1"
4	102	220	500	920	1380	2640
6.3	150	340	760	1400	2100	3900
8	180	430	950	1750	2540	4980
10	240	539	1170	2170	3249	6000

Tablo 3

## HAVA HATLARININ ÖZELLİKLERİ

Genelde hava ile çalışıldığında, alan üzerine uygulanan basınçtan yararlandığında basıncın randımına etkisi basıncın karesi ile orantılıdır. Bir başka deyişle 6 Bar yerine 5 Bar basınç geliyor ise verimlilik (5X5=25, 6X6=36) %70 daha düşük olacaktır. İşin en kötü tarafı aletiniz daha gürültülü çalışacak, yapması gereken işin süresi uzayacak verimlilik düşecektir. Ne yazık ki bu verim düşüklüğünün operatör tarafından kolaylıkla anlaşılması mümkün olmayacaktır. Ayrıca basınç düşüklüğü çok ciddi ekonomik kayıplara neden olacaktır. Kaybı en düşük seviyede tutmak için ana hatlarda hava akış hızını 6 m/sn'nin altında tutmak gerekir. (Tablo 2) 2100 kW, 7 Bar basınçta 100 metre uzunluğundaki boruda meydana gelen enerji kaybını vermektedir. Hava hızı aşağıdaki formülle saptanır.

$$V=1273 Q/(P+1) D^2$$

$$V=\text{Hız (m/sn)}$$

$$Q=\text{Serbest hava (lt/sn)}$$

$$P=\text{Basınç (bar)}$$

$$D=\text{Boru iç çapı (mm) dir.}$$

Boru çapı (mm)	100 metre boruda basınç kaybı (bar)	Eşdeğer güç kaybı (kW)
40	1.80	9,5
50	0.65	3,4
65	0.22	1,2
80	0.04	0,2
100	0.02	0,1

Tablo 2